

**PAPER - I**

**BUSINESS ORGANISATION AND MANAGEMENT**

**CONTENTS**

1. The Business System
2. The Process of Management
3. Managerial Planning
4. Nature and Process of Organising
5. Direction-Communication, Leadership and Motivation
6. Control : Concept and Process
7. Marketing Management-Nature, Importance and Concept
8. Market Segmentation
9. Financial Management
10. Human Resource Management
11. Change Management
12. Management of Conflict

S.R.S

*Editor :*  
*Dr. Sneh Chawla*



**SCHOOL OF OPEN LEARNING**

(Campus of Open Learning)

**University of Delhi**

5, Cavalry Lane, Delhi - 110007

---

Acad emic Session **2012-13 (10000 Copy)**

---

---

© School of Open Schooling

---

---

Published by Executive Director, School of Open Learning, 5 Cavalry Lane, Delhi-7  
Printed at : M/s. Amety Offset Printers, 12/38, Site IV. Sahibabad Industrial Area.  
Ghaziabad (U.P.)

---

---

## **THE BUSINESS SYSTEM**

---

### **What is Business?**

The ordinary meaning of the word business is busyness, i.e., any activity in which a man is busy. A man may be busy in two kinds of activities: economic and non-economic. An economic activity denotes work or effort directed towards the production of wealth. In other words, economic activity is aimed at profit. Economic activity of a man is called business. Business, therefore, means the production or purchase of goods with a view to sell them at profit. Besides, if services are rendered on payment to others, they shall be included in business. Business may be defined as a human activity directed towards producing or acquiring wealth through buying and selling of goods and services.

The term business includes trade, commerce and industry. The process of buying and selling of goods, is called Trade. Such an activity may be carried on within a country when it is called home or domestic trade. It may be called foreign or international trade when it is carried on between two different countries. To help trade, some facilities such as storing, grading, financing, transporting and insuring are needed, these are called Commerce. Industry implies all those processes, which are responsible for the extraction and production of goods which are sold for either ultimate consumption or for further production. So, we may say that  $\text{Business} = \text{Industry} + \text{Trade} + \text{Commerce}$ . We shall discuss the various components of business at the end of this lesson.

**Business Provides Services.** There are service enterprises, which provide services like domestic services and financial services, etc., to individuals and business enterprises. Take the example of cinemas or hotels, they render services to the community at large. As observed by Urwick and Hunt, "A business is any enterprise which makes, distributes or provides any article or service which other members of the community need and are willing to pay for that."

### **How Business differs from profession?**

You have already noticed that a business enterprise may provide services but there are many individuals and firms that may also render services. These individuals or firms are a body of professional people, such as doctors, lawyers, engineers, etc. who may render one or the other useful services. But professional services are not business even when they are rendered in return for money. A professional like a doctor or lawyer renders a personal service of gaining intimate knowledge of a particular individual. On the other hand, a businessman is not concerned with the need of particular individuals in a general way. A human need begins to interest him only when it is widespread and general. It is when a need becomes a general and ripens or matures into demand that it comes within the scope of business.

Business is a social activity. All parts of society are related with it in one way or the other and contribute in its success directly or indirectly. The society provides inputs to business in the form of men, machines, materials, money etc., and expects useful goods and services from it at reasonable rates and adequate wages for its employees and correct taxes for the State. A business house cannot afford to ignore its social responsibility. For example, if a business house fails to please its employees, it leads to employees' unrest causing disruption in its normal functioning and the existence of a large number of such irresponsible business houses may become the cause of national unrest.

## Motives for Business

Following factors provide motives to business:

1. Ambition to earn profits
2. Psychological factors
3. Ambition to provide service

These factors are now discussed vis-à-vis the motives they provide.

**1. Profit Motive:** Personal gain is one of the supreme motivating forces. Business is that sphere of a man's activity where the amount of effort determines the size of profit. It is needless to say that greater personal effort brings in greater monetary reward. This single factor has resulted in the establishment, running and expansion of business by individuals or group of individuals.

**2. Psychological Factors:** It is an old saying that a man does not live by bread alone. It is equally true in business. An entrepreneur may not work solely for amassing fortune. He may be guided by the ambition to build up a business empire. The biographer of William Lever, the founder of Lever Bros, Charles Wilson quotes Lever, who once said "*My happiness is my business*". To grow and become big and to find an industrial empire has been valid psychological factors for business.

**3. Service Motive:** It is also a great motivating force. Many people are motivated to render some service to their community. Henry Ford, the founder of Ford Motors stated that "Money chasing is not business". In our country Jamsedji Tata built a steel plant with a great missionary zeal. Business have been founded with service as their motive.

An enterprise must earn profit to remain intact and to grow and this element draws men to business. At the same time it is necessary that an enterprise must produce goods and services of the type and quality that the customers want, must offer right kind of employment conditions to its employees, and the society must accept it as a useful institution. In fact, the mixing or blending of these two elements is necessary for any business enterprise. Of course profit is a significant motive for business without which an economy under capitalism may not grow. Consistent growth of an economy is necessary to provide more employment and a better standard of living. Thus the two motives must co-exist in a business enterprise for its existence, growth and status as a useful institution.

The above discussion is more relevant for a private enterprise. Let us now consider the purpose of a public enterprise. The guiding factor in the case of a public enterprise is service but it shall be wrong to remark that a public enterprise should exist only for a few services. Profit may serve as a useful purpose where it is used for the economic growth of the country. It may be concluded that both types of enterprises should aim at not only the profit but also rendering service.

Let us consider the profit from the point of view of a corporation or joint stock companies. The structures of modern economies are such that industrial, trading and commercial activities are carried on by these corporations. These corporations are owned by the shareholders and managed by managers who are not very much interested in them as owners. These managers work for the good of shareholders, employees and consumers. Thus, they are liable to earn profit for the shareholders and to fulfil their obligations towards others. They are motivated to work hard not because they would gain some individual profits but because the profit being more would give them satisfaction and status. These managers aim at improving the process of marketing and production to earn more profit. The skill of these people is always at trial. In the process of proper planning for marketing and production, the manager of a large company applies *Profit Test* and the *Profit Motive*. The latter is associated with individuals. In the long run, profits do indicate the health of a business enterprise vis-à-vis the consumers, the labour force and the shareholders. For example, lack of cooperation on the part of labour shall certainly mean lower profitability. The profit test, however, implies satisfactory profit and not huge profits. The importance of this test is immense. After all, on what basis you would assess the performance of a business enterprise? Even in communist countries

this kind of test is being applied to a business unit to measure the efficiency of the enterprise. In our country too, the public enterprise pursue profit motive with the aim of generating surplus for planned growth.

So, both the profit motive and service motive are essential for the very existence of business. Profit is essential for making provision for depreciation, for paying better wage rates to employees and for the expansion of business. The huge size of big business houses like D.C.M. or Mafat Lal Group which we see today is primarily because of ploughing back of these profits. Service motive directly affects the profitability of a business. Poor service leads to lesser sales volume and hence low profits. Moreover, to provide service to the community is the social responsibility of a business. Littlefield had rightly remarked that business must earn profits sufficient to compensate the owners for the use and risk of capital, must serve varied needs of employees and must contribute to the stability and progress of community. What may have started as purely economic venture for maximum profits may soon take on social and political dimensions. Further, in an economy such as that of India, where millions of business organisations create the major part of the nation's wealth, income and employment, it is easy to see that the collective impact of the business is very great indeed.

### **What is Organisation?**

This has been defined in a variety of ways by various authorities on the subject. The essence of the various definition is best reflected in the definition given by Haney. He defines organisation as a "*harmonious adjustment of specialized parts for the accomplishment of some common purpose*". In simple words, organisation is putting together of men, material and machines to achieve the defined goals. Through organisation there is cohesion, which result in efficient functioning of an enterprise and resulting into profits to the enterprise, more wages to its employees and lower cost of goods to the consumer. Thus, the economic gains of such an enterprise are more and social costs are less.

### **Businessman or Entrepreneur**

Before we conclude our study on the nature and purpose of business, it would be proper that we cast a look at the businessman. Businessman, in simple words, can be defined as provider of goods and services to people, which they need but do not possess. He takes the initiative and the risk to produce or market goods and services. He therefore, with his foresight exploits an economic opportunity. He makes business plans and executes them with a view to earn profits though it does not mean that every businessman makes profits. Some may even lose because of the uncertainties of economic factors. Entrepreneur binds the factors of production for the objectives already stated. Thus he guarantees wages to his employees and interest to the lenders of capital. All that we have so far stated about him would necessarily imply possession of certain qualities on his part. Let us now consider the qualities that a businessman must possess.

### **Features of Business**

The common features of a business can be given below:

- (a) **Dealing in goods and services for value:** Business provides goods and services to society. The goods may be for consumption or for production. The first type of goods are called as consumer goods, e.g., clothes, shoes, fans, sugar etc. and the second type of goods are called as capital goods, e.g., plant and machinery. These goods and services are meant for sale. The goods and services produced for personal consumption are not within the scope of business. So, when a person repairs his own scooter, it is not business but when he opens a repair workshop that becomes business.
- (b) **Recurring nature of transactions:** A single transaction of sale or purchase or any dealing casually does not amount to a business transaction though it might have resulted into profits. A transaction comes under business only when it occurs at regular intervals or it is recurring in nature. For example, where a person sells his scooter that is not business. But if he opens a garage and keeps a stock of scooters for sale that would constitute business.

- (c) **To earn Profits:** Business is a human activity directed towards earning wealth. Profit is essential for the livelihood of the entrepreneur as well as survival and expansion of the business.
- (d) **Increase in Utility:** Business activities create utility in one form or the other. Manufacturers convert raw materials into finished products: whole salers, retailers and transporters etc. help in their distribution. Thus each one of them increases the utility of goods.
- (e) **Risk element:** Business is full of risks. Profits do not depend solely on efforts of entrepreneur. Certain other forces may intervene over which a business man had no direct control. These factors may be changes in consumer tastes and fashions; changes in technology, strikes; power failures; loss by fire and theft etc. Some of these risks can be passed on to others by means of insurance while some risks have to be borne by businessman. Most of the business decisions relate to future and future is full of uncertainties. It is because of these uncertainties that business is also called as an adventure.

### Qualities of a Successful Businessman

A successful businessman is an asset to a nation. He helps to discover new processes, products and uses of goods. And he helps in the creation of income and wealth for a nation. He produces or markets those goods and services which are needed most by the people. These functions require talent to direct and to lead people who shall be working towards the common purpose. In other words, a businessman must possess some qualities. These have been summed up as under:

1. **Time Sense:** A business cannot accomplish anything without time sense. This implies that he should take decisions carefully since one decision may affect other decisions in his business.
2. **Alertness:** Without this quality, a businessman can not hope to go far. He should know the changing pattern of demand, changes in technology and what his rivals are doing. All this he can know only if he is alert.
3. **Honesty:** Honesty creates a permanent market for a businessman. A businessman cannot hope to survive in business unless he depicts true quality of his products before the buyers.
4. **Ability to Cooperate:** A businessman must have the ability to cooperate and adjust with persons with whom he deals, especially his customers. He must realize that he too could be wrong and he should make amends.
5. **Dependability:** In order to permit smooth functioning of the organisation which a businessman has evolved, it is necessary to make the organisation dependable at all times, all people in the organisation know their functions and thus dependability is ensured.
6. **Energy:** Mental and physical energy on the part of the businessman would make the business a success. Vigour always inspires confidence.
7. **Character:** No other single factor may build business so much as this single factor alone may. Character lends value and credence to ability to cooperate, dependability and alertness. In simple words the character builds business.
8. **Ability to lead:** A successful business must have basic leadership quality to lead his co-workers. Leadership quality is cultivated.
9. **Education and Training:** A sound education and proper training in the conduct of business would certainly make businessman more successful.

From our discussion we can conclude that the term business is very exhaustive in scope. The variety of activities included in the scope of business have one feature common and that is the goods produced are to be sold and that too for making profit. Therefore, goods produced for personal consumption do not fall within the scope of business.

The regularity and recurring nature of buying and selling transactions is another important characteristic of business. A single transaction does not constitute business. For example if I sell my study table to you and make some profit in this transaction, it does not amount to business. If I maintain a stock of furniture and sell it to customers, it will amount to business.

Profit is the main stimulus for promoting and continuing a business. It is essential for its survival and development. But for the continuous existence of a business, it must fulfill its social responsibilities.

Another characteristic of business is that the profit earned by business does not depend only on the efforts of the entrepreneur but also on many other factors not wholly under his control. Business is full of uncertainties, hence full of risk and because of this reason it is sometimes described as an adventure.

### **Requisites of a successful business**

A successful business must bring a compromise between the conflicting objectives of providing goods and services to consumers and social responsibilities. That a business may have started purely as an economic venture for maximum profits may soon take on social and political dimensions. To achieve its different objectives a business system should continuously strive to fulfill the following requisites:

1. Before establishing any business both long range and short range objectives should be established.
2. Planning should be given due importance. To plan is to propose a forward programming for guiding the future functioning of an enterprise.
3. Proper location and layout of the plant and suitable size of the firm contribute substantially to the success of a business system.
4. The organisation must be clearly defined. It should be adequately manned with competent personnel.
5. It must have an up-to-date knowledge of the latest developments in the field of technology.
6. Research in all aspects of business, e.g., product research for ensuring success in the long run.
7. Last but not the least is the requisite of efficient management.

### **Rise of Professional Manager**

Management of a business enterprise has become the most important aspect of its functioning. In fact, it would not be an exaggeration to say that proper management of an organisation is necessary for its survival. There are many challenges to modern management, which are stated below.

**1. Complexity of modern industrial structure:** The Industrial revolution brought about a complete change in the techniques of output and their ultimate organisation. This change has made the modern industrial structure complex. Modern industry is capital intensive which necessitates the demand for a large amount of funds. To meet this challenge of fund raising, it became necessary to discover a form of organisation that would meet this demand. Man's talent to invent led to the formation of the joint-stock company. The large size of business created the problems of managing it properly. A very high degree of managerial skill is needed to run a large business enterprise since risks are large and managers cannot experiment with ideas. An error of judgement may prove very costly and the organisation may end abruptly or suddenly. Another factor is the divorce between ownership and management which is the direct result of the company form of organisation. This adds further to the complexity of modern industrial system in societies under capitalism. Thus, the modern industrialism is (what Galbraith calls Techno-structure) which consists of a group of people working together.

**2. Size of the Markets:** This is a major challenge of industrialisation whether it is of the capitalist or of the communist variety. Size of the markets is the testing ground for managerial efficiency. The large size of markets is the direct result of technology and mass production. Marketing of products has to face many a problems, e.g., the competition, introduction of new products, better consumer servicing, increase in the demand for existing



products, to ensure a minimum growth rate of the enterprise and so on. The manager must be conscious to these tasks and meet the challenge of wide markets and the problems associated with them.

**3. Tariff Barriers and Export-Import Regulations:** No country can live in isolation today. International trade is necessary for every nation for its economic survival since no single country is self-sufficient in all respects. Every country regulates its export and import trade through various means like export duties (tariff barriers as they are called) and import levies to protect the economic welfare of the nation. The enterprise that is engaged in export and import faces the challenge of barrier of levies and duties in its own country and other countries.

**4. Effect of Trade Cycle:** Cyclical changes take place in the economic activity of the country. Sometimes the demand for certain goods and services is high while at any other time it is low. Higher demand means greater profits while lower demand results in lesser profits. This is the effect of trade cycles on demand. An element of great risk and uncertainty gets introduced in the economy. In fact it may be correct to say that challenge of change and of uncertainty is a great challenge and the management must give adequate response to this factor.

**5. Governmental Control:** Government enforces control over business for the general economy. There is challenge inherent in the governmental action of controlling the business. The government regulation of business can be through the Companies Act, Labour Act, Licensing of enterprises, taxation law etc.

To meet the above challenges of modern business adequately it would be desirable that managers should be sufficiently trained and available in sufficient numbers. In the West, professional manager has come of age. In our country too he is emerging and in the next decade or so, he is going to play still more dominant role. Some of the large joint-stock companies are being managed by the professional managers who are quite different from the owner-managers. Many universities and specialized institutions now impart business education to managers-to-be and existing managers at different levels.

### Components of business

Business is an all embracing term. It includes trade, commerce and industry. Business can be classified into two broad categories (a) *Industry* and (b) *Commerce* (including trade). Industry is concerned with the production of goods, and commerce with the distribution of what is produced.

**Industry:** The process of extraction, production, conversion, processing or fabrication of products are described as industry. The products of industry are sold either for further transformation into finished goods or for ultimate consumption. Goods used for final consumption are termed as consumers' goods, and those used in production of other goods are designated as producers' goods. A steel mill may make steel for further fabrication into a variety of articles, such as surgical blades, etc, or engineering concern may make machine tools and machinery to be used for manufacturing other products. These are called capital goods.

### Types of Industry

Broadly, an industry is either *primary* or *secondary*. Primary industry may be either extractive or genetic, and secondary industry is either manufacturing or construction.

**Extractive Industries:** These industries are engaged in supplying commodities, which are extracted or raised from the earth, sea and air. The products of such industries are generally used by manufacturing and construction industries for making finished goods. Fishing, mining, fruit gathering, agriculture and afforestation are some of the examples of extractive industries.

**Genetic Industries:** These are industries which, though dependent on nature, require a greater application of human skill in their production than extractive industries. The enterprises engaged in cattle raising, fish culture and nurseries are examples of genetic industries.

**Manufacturing Industries:** Manufacturing industries are concerned with the working of raw materials or partly finished materials into finished products. Manufacturing processes are carried on chiefly in factories and



constitute a very large part of the total business activities. Among the manufacturing industries may be mentioned the iron and steel works, spinning and weaving mills, flour mills, the making of machinery, etc.

Manufacturing industries may be either continuous or an assembly type. A continuous industry is one in which all the materials are received at one point, from which successive operations turn these into a finished product. Yarn spinning, paper and pottery manufacture are examples. In an assembly industry, the finished product can be produced only after various components have been made and then brought together for final operations. Manufacture of shoes, automobiles and garments making fall in this category.

**Commerce:** The process of buying and selling and all those activities which facilitate trade, such as storing, grading, packaging, financing, insuring, transporting are called commerce. The principle function of commerce is to remove the hindrances of person, place, time, exchange and knowledge, in connection with distribution of commodities until they reach the consumers. By removing these hindrances commerce ensures a free and smooth flow of goods from producers to consumers. A brief description of these hindrances is given below:

**Hindrances of persons:** Buyers and sellers of goods and services are not always found at the same place so that contact between them is hindered by distance. Commerce helps to remove this hindrance between persons by means of trade. Trade as part of commerce therefore plays a major role in establishing contact between sellers and buyers.

**Hindrance of Exchange:** With money as the medium of exchange, payment for goods and services is made possible through institutions such as the banks. In this way, banks as part of commerce act to remove the hindrance of exchange and enable buyers to procure goods, especially by extending their own credit.

**Hindrances of place:** The goods may be produced at one place and the demand for them may be greatest at a different place where they are not produced. This barrier of distance is removed by commerce through the different means of transport and the goods are carried from one place to another.

Added to direct movement of goods from the points of production to the points of consumption are the services of insurance to cover the risk of loss and packing to protect goods against damage and pilferage.

**Hindrances of Time:** Goods are often produced in anticipation of demand. They must therefore be stored in a safe place to be released as and when demanded. The function of storing and preservation is performed by warehouses. The warehouses remove the hindrances of time by balancing the time lag between production and consumption, and so create time utility. Insurance comes into play where goods are stored in warehouses and cover the risk of loss or damage through theft or fire.

**Hindrances of Information:** Selling of products is today the most important problem that a manufacturer has to solve. His product may be the best, but unless the prospective buyer knows about them they remain unsold. Advertising and personal salesmanship help to remove this hindrance of the lack of knowledge or information by bringing to the notice of the people the advantages of buying the goods and services offered.

To sum up, commerce may be said to be that branch of business which facilitates exchange of goods by removing the various hindrances, namely, those of persons through trade and of exchange through banking; of place through transport, insurance and packing; of time through warehousing and insurance; lack of knowledge or information through advertising and salesmanship.

Stephenson defines commerce as “the sum total of those processes which are engaged in the removal of hindrances of person (trade), place, (transport and insurance) and time (warehousing and insurance) in the exchange (banking) of commodities.

**Trade:** Trade is the fundamental state of business activity and involves the sale and purchase of goods and services. It is to facilitate the transfer of goods from the seller to the buyer that all the above mentioned activities are undertaken.

**Types of Trade:** Trade may be (a) Internal or domestic, or it may be (b) External, Foreign or International. Internal trade may in turn, be (i) wholesale trade or (ii) retail trade. Foreign trade would be (i) import trade and (ii) export trade.

Internal trade, also known as home trade or domestic trade, comprises of buying and selling of goods within the bounds of a country. It may be wholesale or retail trade. Wholesale trade relates to purchase of goods in large quantities from producers and growers and their resale to retailers in small lots. It serves as a link between the manufacturers or producers and retailers who sell them to the ultimate consumers. Retail trade is the last link in the economic chain whereby human wants are satisfied. The retailer assembles at a convenient place, his shop or stores, various types of products from numerous sources and supplies these in small quantities to consumers.

Foreign trade refers to buying of goods from or selling commodities to traders doing business in foreign lands. Foreign or international trade is normally wholesale trade and takes the form of import or export, or it may be entreport trade. By import trade we mean buying goods from suppliers in foreign lands and by export trade selling to buyers in foreign countries. Entreport trade consists of importing foreign produced goods merely with the object of re-exporting them.

## **BUSINESS SYSTEM**

The objective of this lesson is to introduce to the students the broad spectrum of Business System rather than its detailed exposition. The study of business system shall be restricted to its panoramic perspective, rather than to a close up. In simple words, system means an assemblage or combination of things or parts forming a complex or unitary whole. It is an establishment or arrangement of parts for achieving the desired objectives. A system may comprise of different sub-systems and it may itself be a part of another broader system. All these are inseparably related with each other like the gear in a machine and has to operate in a coordinated way to achieve the planned objectives. For a clear understanding of a system, it is necessary to know the interrelationships of sub-systems in order to find out how they are interrelated. When the study of a phenomenon is undertaken in this manner, it is called a 'systems analysis' or a systems approach'

The meaning of the term 'system' can be best understood by taking the example of human body system which in itself consists of various sub-systems like digestive system, respiratory system, nerves system etc. These sub-systems have further sub-parts. All sub-systems of the human body system must function in a closely coordinated way. The interrelated sub-systems form a unitary whole i.e., a human being who is himself a part of the environment and the society in which he lives.

A *sub-system*, in our context, may be defined as a departmental activity within the framework of a functional activity. Respective departments set their objectives within the framework of functional objectives and accordingly this may be defined as sub-objectives. Like a human body system, a business system too consists of various sub-systems like production, financing, marketing, personnel etc. which operate in unison to make the unitary whole i.e. a business system. These sub-systems may have further sub-systems. For example, personnel sub-system is divided into other sub-systems like selection, training, remuneration, promotion etc. The success of any business system as a unitary whole depends on the close coordination of these sub-systems.

Another way of distinguishing sub-systems is according to activities and accordingly each business may have the following sub-systems :

- (a) A decision making sub-system to produce plans and shape the activities of the enterprise as a whole.
- (b) A processing sub-system which procures information, materials, energy etc. and converts these into salable products.
- (c) An information handling sub-system specially concerned with the use of accounting data.
- (d) A control sub-system to ensure that actual performance is according to plans.

- (e) A memory sub-system to store information and make it available as and when required.
- (f) A sensory sub-system to measure significant changes in both, the system and its environment.

A business house as a system is a part of the broader system i.e. the industry to which it belongs and the industry is a part of the entire industrial set up and that industrial set up is a part of the national economic situation. Thus, there is a chain of complicated relationships each affecting the other.

A business can be regarded, from the angle of the system approach as an entity or a system functioning in the social, economic and political environment of the country or even the world. The use of the ‘system’ theory in the study of a business enterprise is really quite complicated because it is difficult to know where to draw a line of distinction that separates a firm as a unique entity from its environment. Present day business cannot function in vacuum. It has to take a serious note of the social, political and economic environment in which it functions. It has the social responsibility and unless it proves its commercial viability and its concern towards the interest of consumers, employees, creditors and the society in general, it simply cannot survive for long. When undertaking the study of a business system, we are concerned not only with the structure of the business system but also with its environment because these environmental factors have a direct bearing on the smooth functioning of a business system and its environment.

Now we shall try to explain in detail, how the environment affects a business system. The environment may be:

1. **Economic environment** —As already stated in this lesson that, no business exists in a vacuum and cannot independently control its destiny, as it is subjected to external influences over which it has no direct control. A business must suitably react to these external influences in order to survive. A business firm belongs to a particular industry: manufacturing, banking, insurance, mining and so on. These industries are the essential element of national economic system. The national

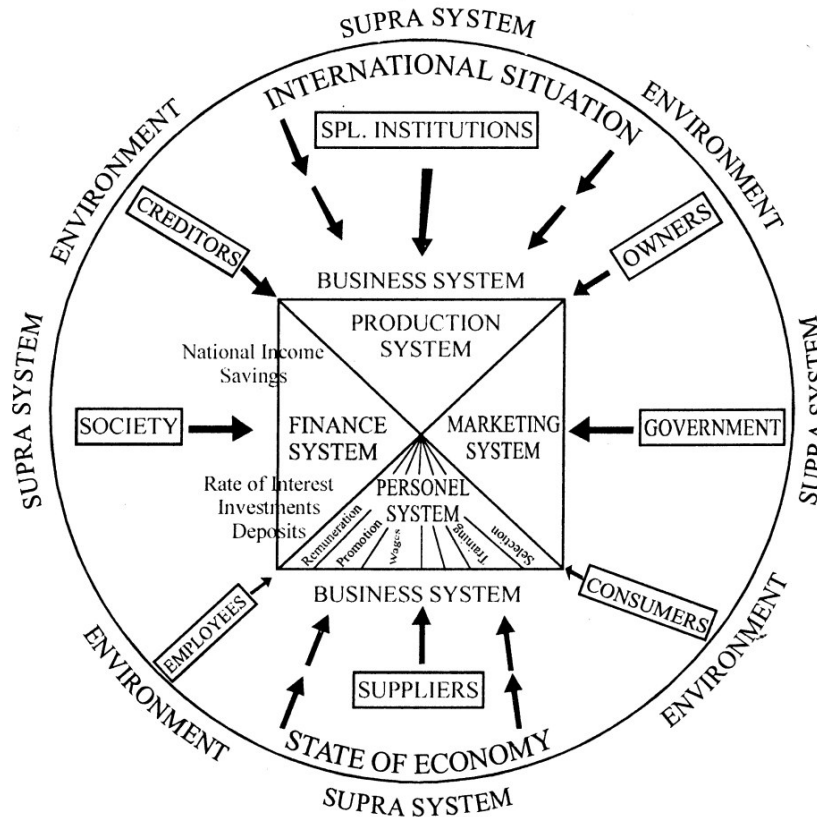

Figure : 1

economic system cannot exist in isolation either, as it is an integral part of the world economic system. Both national and international economic forces influence the demand for the product of a particular business. Production programmes of business firms are affected by these economic forces and the production programmes in turn determine the resources required in the shape of raw materials. The availability of these resources is also dependent on political, economic and social circumstances prevailing within the countries supplying raw materials.

Demand affects the level of employment at home and abroad. Increase in demand at home for consumer goods creates additional demand for new plant and machinery, in order to expand its production which may be purchased from home capital goods industry or from abroad. It may create balance of payment problems, if purchased from abroad which have to be financed either by additional exports or by loans from international financial institutions.

2. **Technological environment**—The demand for a product is affected by the technological changes. Consumers respond to technological changes and demand for products incorporating the latest technology. A business must be quick to respond to these technological developments. Examples of this include transistorised radios and changeover from metal products to plastic or fiberglass products. A business can retain its share of production or increase only by quick response to technological developments and for this market research is a must.

3. **Financial environment**—A business unit cannot remain unaffected by the financial environment existing in the country. For instance, the economic crisis in a country may be reflected in the financial position of those business houses who have to suffer from deficiency of liquid funds. Economic crisis, leading to lower level of demand cause fall in production which in turn leads to increase in fixed cost per unit thus reducing profit margin of per unit sold. Even where a business can obtain some short-term finance in the form of loans, the interest rate is quite high which further increases the financial overhead burden.

4. **Sociological environment**—The employees of today are developing a new sociological outlook. The present-day employees cannot be effectively controlled in an autocratic fashion. They want to participate in the management process. This calls for democratic approach in management and for that management has to change its traditional approach towards the personnel or labour.

5. **Legislative environment**—A large number of government legislations like the Companies Act, the Industries Development and Regulation Act, Income Tax Act, Sales Tax Act etc. affect the activities of business.

From the above discussion it is clear that a business manager has not only to integrate the men, machine, material, information and money into the business system but he has also to coordinate these with the environment in which these exist. A business system has to adapt to the changes in environment like the change in the economic policy, change in demand, and other political and social changes. Above all this, he has to take into account the international market situation.

Business system is an open system because it recognizes the existence of external environment which affects its performance and which in turn is also affected by the business system. It is not at all a closed system which is a self-contained unit completely detached from its external environment. Like a human body system, which constantly adjusts itself to the external environment, an open system too is characterised by its capacity of self repair.

Business Organisation is the hub or the central part of any business system. It has the usual features of a system:—

1. *Plans*—objectives, policies, procedures etc.
2. *Inputs*—men, machine, material, money etc.
3. *Processing*—activities concerning producing, financing, marketing, personnel, etc.
4. *Output*—goods and services to society.
5. *Feedback*—alteration and modification of plans and activities if needed. See Figure No. 2

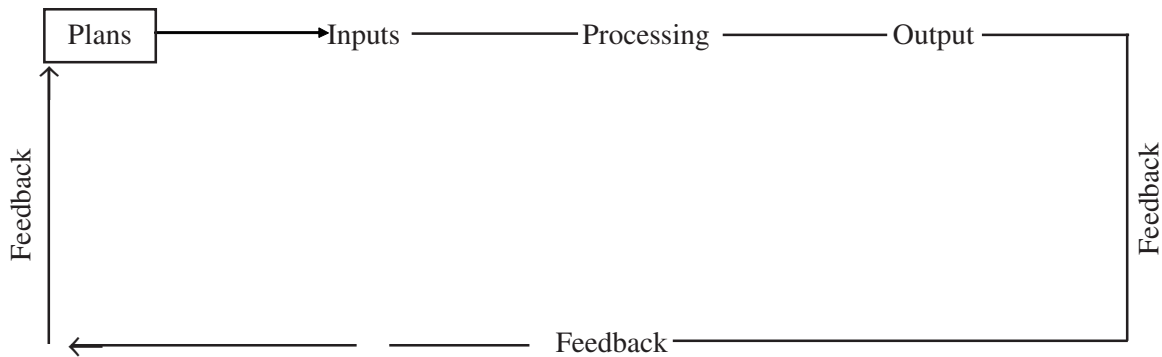

Figure : 2

### The Feedback Concept

The feedback concept is concerned with the process of increase or decrease in the support to a business unit in response to its performance. In our study, it refers to the arrangement by which society gets various outputs from business in return for the inputs and the society increases or decreases the inputs provided to the business system depending upon the satisfaction derived from the output of business. Feedback is necessary to feed the various sub-systems in the organisation with the requisite information. For instance, if the results of any business unit reveal that the quality of its products is not upto the mark, it will necessitate the steps for higher quality production. But suppose the results as such are not acceptable, it will call for modification of the plans. This may be described as the systems' approach to business organisation. This approach highlights the integrated complex, each sub-system inter-related and well co-ordinated with each other so that the whole firm functions in unison.

From the above discussion, it is clear that systems' approach is always goal oriented. The systems' approach is the most appropriate method of organising and evaluating a business house and its performance. An organisation has to continuously work to bring the best balance between a mass of conflicting objectives like service to society and dividend to shareholders. It has to reconcile the various objectives of business in such a way that will provide the maximum satisfaction to the total system.

A business system on the whole is something more than just the aggregation of all sub-systems in it. It is responsible for transforming the inputs into outputs to satisfy consumer demands. An organisation has to develop sensitivity to know the changes in its environment and adaptiveness to the demands of its environments, if it has to accept the challenges and also ensure its survival and growth. Feedback is necessary to achieve this objective.

The systems' approach to a business organisation draws the attention towards the integrated complex system, each functional part integrated with others so that the 'whole' moves in unison. The interesting feature of a business system is that its various parts are inter-related and interact with each other, while the business system on the whole, interacts with its environment. The business system affects its environment by its output and is itself dependent on its environment which increases or decreases the inputs according to the satisfaction to the society. So, an efficient business system should not only be a suitable mix of its various sub-systems but it should also be in tune with the changing environment. Thus a systems' approach highlights the fact that the business system and its environment are inseparable and feed-back is necessary from one sub-system to another sub-system so that the process of providing goods and services to the society continues smoothly and efficiently.

\*\*\*\*\*

## LESSON 2

---

# ENTREPRENEURIAL PROCESS

---

The process of promotion of a business enterprise begins with the conception of an idea in the mind of an enterprising person which is later on converted into a business proposition.

*Promotion may be defined as the discovery of a business idea and the subsequent arrangement of funds, assets and personnel and converting these into a business enterprise for the purpose of making profit therefrom. In the words of Guthmann and Dougall, "Promotion starts with the conception of the idea from which business is to be evolved and continues down to the point at which business is fully ready to begin operations as a given concern".*

### **Promoters**

The person who performs the function of promotion is called a promoter. The term promoter sums up in a single word a number of business operations familiar to the business world which are necessary to bring the company into existence. He is the person who originates a scheme for the formation of a company, has the necessary documents prepared, executed and registered. He finds the first directors, makes preliminary contracts and makes arrangements for capital.

Most of the business enterprises are promoted by occasional promoters. These promoters are interested in the promotion of a particular company. Promotion of business enterprises is not their profession but they are simply 'pro has vice' promoters. In Western countries, professional promoters are quite popular. Their profession is to promote a company and then hand it over to the shareholders. In our country, professional promoters as an institution do not exist. Recently, some of the State industrial development corporations have come forward to promote companies in collaboration with private entrepreneurs. Industrial development corporations keep their nominated persons on the board of directors of the company promoted by them. Technocrat promoters have also come to limelight in the last few years. Engineers, professional managers, consultants and advocates join hands to promote a company. The companies promoted by the technocrats are invariably managed by them though these may be small in size.

### **Steps in Promotion**

The process of promotion passes through a number of stages which can broadly be divided into the following two categories:

- A. Those relating to planning and organising of the business; and
- B. Those relating to legal formalities to be observed to bring the business enterprise into existence.

#### **A. Planning and Organizing**

The problems involved in the planning and organising of a business enterprise are common to all forms of business organisations but the legal formalities differ from one form of business organisation to the other. An establishment of sole-tradership hardly needs any legal formality but for the formation of a joint stock company, complicated legal procedures are required. The work involved in the first category can be further sub-divided into following heads for the sake of convenience;



1. Discovery of an idea.
2. Detailed investigation of the idea.
3. Assembly of the Factors of Production.

### **1. Discovery of an idea**

As stated earlier, the promotion of a business begins with the discovery of an idea. The idea may be an absolutely new one. It may be an invention or a new method of production needing commercial exploitation. The idea may be to join the existing lines of production or trading. In case the promoter is not acquainted with the commercial possibilities of his idea, he seeks the guidance of some experienced persons. He has to ensure, at this stage, whether the necessary permission from the government will be available to establish the proposed production or trading, otherwise, if it is found afterwards that the licence for the proposed activity is not available, all his efforts would go to dogs. Thus at this stage, promoter decides about the nature of business and ensures about its commercial viability.

### **2. Detailed Investigation**

Having determined the commercial possibility of his business proposition, the promoter has to investigate it in detail in order to find out its commercial soundness in terms of profitability. This is the most crucial and difficult stage in the promotion because at this stage promoter has to find out answers to a large number of problems which are not only complex but also different in nature. In case the business idea is absolutely new, finding answer to these problems becomes even more difficult. As it is difficult for the promoter to resolve all these complex problems, so, he takes the help of marketing, technical, legal, financial and management consultants. Some of the important questions to be answered at this stage are:-

1. What will be the size of business unit proposed to be established?
2. What will be the range of products, markets covered and volume of sales and at what price?
3. What will be the location of business unit?
4. What will be the amount of capital needed?
5. What will be the sources of collecting the capital needed?
6. What will be the sources of raw materials needed for production?
7. What will be the sources of energy requirements?
8. What will be the sources of machinery and equipments?
9. What will be the form of business organisation?
10. What will be the internal organisation of business?
11. What will be the personnel needs of the business unit?
12. What will be the taxation problems of the business?

If we look at the above problems carefully, we find that these problems overlap each other. No problem can be decided in isolation. For example, the nature of business determines the size of business but the size of business is also determined by the demand of the product, amount of capital available, the production capacity sanctioned by the government and so on. Again, on the size of business depends the form of business organisation and its internal organisation.

Where any raw materials, machinery, technical services etc. are needed to be imported, he must first ensure that the necessary permission is available from the government. So the promoter has to find out solutions to all the above posed problems within the constraints set by the government.



After the detailed investigation of all the above complex problems, if the promoter arrives at the conclusion that it is possible to establish the business and the profits expected to be generated by the business are sufficient to justify the proposed investment in that proposition, then he puts all his findings in black and white in the form of a report. This written account of various aspects of the proposed business is called a Project Report. With project report in hand, the promoter becomes competent to take necessary steps to launch the enterprise because it serves as a basis for procuring finance from financial institutions and obtaining necessary licences from the government agencies.

### **3. Assembly of the Factors of Production**

At this stage, the promoter takes necessary steps to assemble the various factors of production of his business proposition so that every thing; is available on time when the business comes into existence and the project execution is not delayed for want of any thing. The important things to be settled at this stage are:-

1. To ensure that necessary funds will be available in time.
2. To make arrangements for obtaining patents, if needed.
3. To make arrangements for purchasing machinery, equipment, land and machinery.
4. To ensure that necessary personnel will be available.
5. To share his idea with few resourceful persons to whom he would like to associate in the formation of the proposed business enterprise.

At this stage, in the process of promotion of business enterprise, the promoter does not actually procure the factors needed for the business but he simply takes necessary steps to ensure their availability. For example, he may make agreements with the suppliers of machinery and equipment to buy when the business comes into existence. Similarly he may enter into an agreement to buy land and for that he usually pays some advance money. At this stage of assembly of factors of production he never does outright purchase, he only enters into a buying option. Such contracts which are done on behalf of a company yet to be formed are called as preliminary contracts. Having completed all the above listed tasks, he would proceed to take the necessary steps to complete the legal formalities to bring the business enterprise into existence.

### **B. Legal Formalities**

When the promoter, decides to have sole proprietorship as his form of business organisation no legal formalities are required to establish the firm as such. He has to simply obtain a licence from the local authorities to establish his business, where the type of business requires so, for example, restaurant, fire works, fire arms business etc. In case he decides to have partnership as the form of business organisation, almost no legal formalities are required to bring it into existence. Partnership Act does not make the registration of a firm compulsory. But the registration of firm becomes necessary, indirectly, because certain disabilities are attached to an unregistered firm e.g., it can not sue for its rights against outsiders. However, an unregistered firm can get itself registered at anytime. Registration is compulsory in case of a co-operative society and a joint stock company.

A co-operative society must get itself registered under the Co-operative Societies Act, 1912 or the State Co-operative Society Act. The formalities required are almost the same under both the Acts. Each State has a Registrar of Co-operative Societies who registers, the Co-operative Societies. For getting the society registered, it must have at least 10 adult members. The application filed with the registrar for registration must contain the information regarding the name of society, its aims and objects and details of its share capital in case it is proposed to be raised by issuing share capital. This application must be accompanied by two copies of the bye-laws proposed to be adopted by the society. The Co-operative Society may also adopt model bye-laws available with the registrar. The registrar, after a careful scrutiny of the application, issues a certificate of registration to the co-operative society. The legal formalities required to form a joint stock company are quite detailed and time consuming. These are discussed below in detail.

## Formation of a Joint Stock Company

The incorporation of a company brings it into existence as a separate legal entity. The promoters select a few names in order of preference and apply to Registrar of companies on a prescribed form available on payment to ascertain as to which of the names is available of adoption. On hearing from the registrar about the available names, they will decide the name of the company. In the mean time, they will decide the objects of the company, the place where the business is to be carried on, the amount of funds needed to carry on the business properly and the names of the persons who would like to associate as first directors. They will embody their decisions on these matters in the form of a document called the Memorandum of Association. They will then decide as to how the business is to be carried on for achieving the objects of the company, and frame rules and regulations for the company's internal management, which will be incorporated in a document known as Articles of Association.

Memorandum of Association and Articles of Association duly dated, signed and stamped with requisite stamp duty will be delivered to the Registrar with the necessary filing and registration fees. Both these documents must be accompanied by other necessary documents. A complete list of the documents to be filed with the registrar is given below:

1. The Memorandum of Association duly signed by at least seven subscribers in case of a public company and two subscribers in case of a private company.
2. The Articles of Association, if any, duly signed by the subscribers to the Memorandum of Association. A public company limited by share capital may either have its own articles or may adopt table 'A' as given in Schedule I which contains a model set of articles, in case the company does not file its own articles or on matters where the articles of a company are silent, in case of a company limited by shares, the regulations of table 'A' will be applicable.
3. A statement of nominal capital and a certificate from the controller of capital issues, if needed.
4. Registrar's letter intimating about the availability of name.
5. A statutory declaration by an advocate, an attorney or a pleader entitled to appear in a High Court, or a chartered accountant practising in India, who is engaged in the formation of the company, or by a director or any other officer of the company that all requirements of the Act and Rules in respect of registration have duly been complied with.
6. A list of persons who have consented to become directors of the company. If a separate list of directors is not filed, the subscribers to the memorandum will be deemed to be the first directors of the company.
7. If the directors are appointed by the articles or named in the prospectus, their written consent to act as directors and a written undertaking to take-up and pay for the qualification shares, if any.
8. The address of the registered office of the company. This may also be given within 30 days after the incorporation of the company or on the day from which the company commences its business, whichever is earlier.

In the case of both private and public companies, the following two documents, though not required to be filed for the purpose of registration of the company, are usually delivered alongwith the aforesaid documents.

9. A return in duplicate containing the particulars regarding directors, managers and secretary, if any. This has to be filed within thirty days of their appointment.
10. A letter of authority on a duly stamped paper by the subscribers in favour of one of them or any other person authorised for making necessary corrections on their behalf in the documents and papers filed with the Registrar.

When these documents have been filed with the Registrar and the requisite fees paid, the registrar scrutinizes them. If the registrar is satisfied that everything is in order, he will register the memorandum, articles and other

documents and issue under his hand a certificate which is called, Certificate of Incorporation. This certificate contains the name of the company, the date of issue and the signature of the registrar alongwith his seal. The certificate serves the same purpose in case of a company which a birth certificate does in the case of a natural person. On registration, the company comes into existence as a legal person distinct from its members who constitute it. The certificate of incorporation is a conclusive evidence that all the requirements of the Companies Act have been complied with and that everything is in order as regards registration.

## **Raising of Capital**

At this stage the affairs of the company are taken over by the directors. They will elect one of their members as the chairman of the Board of directors, and the board will proceed to attend to the following matters;

1. Appointment of different specialized agencies, viz., Bankers, Brokers and Underwriters, Attorneys, Managers to the share-issue etc.
2. Enter into contracts on behalf of the company in terms of the Provisional contracts. Such contracts are not binding on the company until it is granted certificate to commence business.
3. Enter into contracts with brokers and underwriters in order to ensure the subscription of capital.
4. Drafting the Prospectus and then issue it to public.
5. Making arrangements for the listing of shares on the stock exchange.
6. Allotment of shares to the applicants on receiving applications from them.

Broadly speaking there are three methods of raising capital from public.

- (a) By issuing a prospectus to the public;
- (b) By entering into underwriting contracts so that the sale of entire share capital is ensured; and
- (c) By placing shares. In this case, brokers find persons, normally his clients, who are interested in the buying of shares.

## **Commencement of Business Stage**

As stated earlier, a public company must obtain certificate to commence business, from the Registrar of Companies before it can commence business. To obtain this certificate, the company has to comply with the provisions of section 149 of the companies Act which are as below:

1. To file a copy of the Prospectus with the registrar. Where a company does not find it necessary to issue a prospectus, it has to file a statement in lieu of prospectus. The Statement in lieu of prospectus must contain all the information which a prospectus must contain under the Companies Act.
2. The number of shares allotted in cash is not less than the amount of Minimum subscription mentioned in the prospectus.
3. The directors have paid on shares held by them an amount equal to what has been called up from other shareholders.
4. A statement that no money is, or may become liable to be repaid to applicants for any shares or debentures which have been offered for public subscription by reason of any failure to apply for, or to obtain permission for shares or debentures to be dealt with in any recognized stock exchange.

After the grant of a Certificate to commence business, the company becomes entitled to commence its business and all the contracts entered into by the company between the time from the grant of the certificate of incorporation and certificate to commence business become binding upon the company.

## PROJECT REPORT

A project report is a detailed analysis of different aspects of business-project proposed to be undertaken by the promoters of a business. It states in detail the physical feasibility, commercial feasibility, social feasibility etc. It serves as a mirror of the proposed business project, for all those who are or may become interested in the project in future. This report states the reasons of allocating resources to the production of specific goods and services. The purpose of preparing a project report may be just to make a comparison of different investment opportunities or to submit it to specialized financial institutions for obtaining necessary finance.

A project report or feasibility report facilitates in the planning of business project by setting guidelines for future actions. It provides the framework for providing information regarding proposed business project by the government agencies for granting licences. A project report should cover the following aspects:-

- (a) **General information**—concerning the proposed venture and the examination of the government policy with regard to that industry. It should specify in detail the policy of government in regard to that industry in different spheres, viz. licences, raw materials, location, finance etc.
- (b) **Market Study**—The volume of goods to be provided by the proposed venture and the price. Demand estimates stated at different price levels.
- (c) **Size and Location**—Specifying the minimum production level justified by the techno-economic factors. Problems of locating the project should be discussed in the light of location of raw materials, labour, industrial fuel, transport, market, power, water, availability of land, taxation structure, climate etc.
- (d) **Project Engineering**—This part of the project report deals with the technical aspects of the project which primarily consists of: Preliminary research; Production process; Selection of equipment; Site lay-out; Building lay-out; Work schedules etc.
- (e) **Total Investment**—Specifying the cost of land, building, equipment, patents, cost of instalation, unforeseen contingencies Methods of financing the total funds needed, etc.
- (f) **Organisation**—Form of business organisation to be established and steps taken to achieve the legal status. Organisational chart showing the key positions and the man-power needed to meet the requirements should be given.

A project report should not fail to justify that the proposed project is physically feasible, financially viable, commercially profitable and in the interest of the nation.

\*\*\*\*\*

---

## THE PROCESS OF MANAGEMENT

---

Ever since people began forming groups to accomplish goals which they could not achieve as individuals, managing has been essential to assure the coordination of individual efforts. As we have to depend increasingly on group efforts and as many organised groups have become large, the task of managers has risen in importance. Managers are those persons who are responsible for the work of others. The basic aim of all managers is the same in all types of organisations, that is, to create an environment in which organisational goals can be achieved with the minimum of resources with the help of people working in the organisation.

Management or managing has become necessary because it has been pointed out by many empirical studies that incompetent management has been the cause of most business failures.

There are many views and definitions of management given by the experts and scholars in the field. However, no two definitions are identical and also no single definition has so far succeeded in including all the essential elements of management.

Sometimes the term is used to mean the “group of managerial personnel” in an organisation, i.e., all those from the board of directors down to first-line supervisors. At other times management refers to the “processes” of planning, organising, staffing, directing, and controlling. Management is also used as a body of knowledge, a practice, and a discipline. Others have analysed it as an economic resource, a factor of production, a system of authority, a technique of leadership or as a means of co-ordination or decision-making.

Looking to different views, it is clear that it is very difficult to give a definition which covers all the aspects.

It may be stated that the definition of Harold Koontz is quite widely used, and accepted one. *According to Harold Koontz*, “Management is the art of getting things done through and with people in formally organised groups. It is the art of creating an environment in which people can perform and individuals could co-operate towards the attaining of group goals. It is the art of removing hurdles to such a performance, a way of optimizing efficiency in reaching to goals.”

This definition takes care of the personnel side of the managerial behaviour or human relations approach. But it makes no specific mention of the “processes” of management, which is the most important element of management in any group activity.

Decision-making orientation has become quite important. One of the most important functions of a manager is to take decisions.

**Peter F. Drucker says:** “Whatever a manager does, he does through decision-making.” But it tells about only one aspect of management and does not speak about management as a process.

From “process” orientation, the definition given by George R. Terry is satisfactorily comprehensive. *According to George R. Terry*, “Management is a distinct process consisting of planning, organising, actuating, and controlling, performed to determine and accomplish state;] objectives by the use of human beings and other resources.” It includes the following essential elements.

1. Management is a distinct process.
2. This process consists of : planning, organising, staffing, directing and controlling (although staffing is not given by Terry but this is implied and he has used the word ‘directing’).
3. It utilizes both the human and other resources.
4. It is followed in order to accomplish predetermined objectives.

The following figure gives a graphic presentation of this ‘preferred’ definition of management.

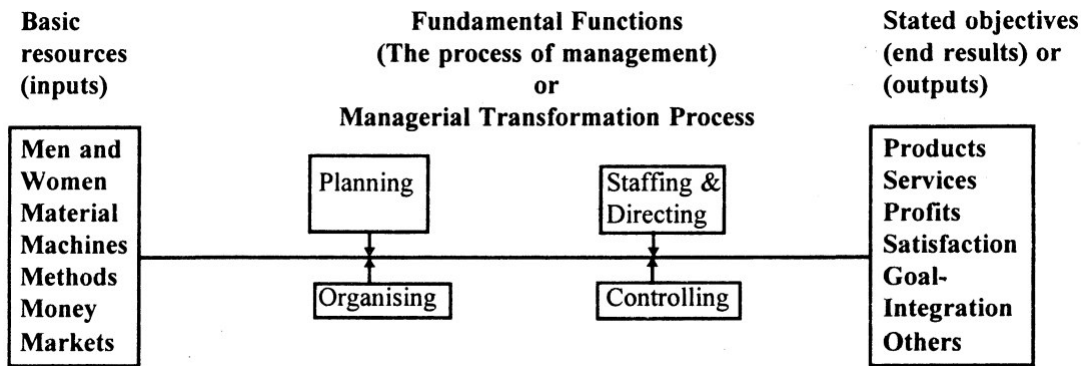

### Some important characteristics of management

**1. Management is an Essential Element of Organised Work :** Management is a process of organised activities of people working towards some purpose. The organised activities may take a variety of forms ranging from a highly formal and structured organisation to very loosely knit organisation. The application of the management process to group activities brings about a coordination among individuals and subgroups.

**2. Management is a Science as well as an art :** Science implies existence of a body of knowledge in a systematised form used upon careful observation, accurate measurement, experimentation and inferences or conclusions derived from detailed analysis of data, i.e. facts and figures. The knowledge is verifiable through experiments which give us the cause-effect phenomenon. Thus science provides the theory, principles and the laws on any branch of human knowledge. In turn, knowledge given by science gives power for application.

Management is a developing science. It has now evolved certain basic principles and elements in the form of management which has universal application in each branch of human activity i.e. profit-making as well as non-profit organisations. However, management is not comparable to exact sciences like physics, biology, etc. It is a social science like economics as it deals with human beings and human behaviour is ever-changing and most unpredictable.

Art is the practical application of some knowledge or skill in order to bring about any desired result. Manager is not only a scientist but also an artist. As an artist, he has to depend on his own experience, intuition and judgement while making decisions on any managerial problem and taking actions on the decisions to realise the set objectives. Management is one of the most creative arts as it requires a vast knowledge and certain innovating, initiating, implementing and integrating skills in relation to goals, resources, techniques and results. Moulding the attitudes and behaviour of people at work towards achievement of certain goals in a changing environment is an art of the highest order.

We can give examples of science and art aspects of management. In planning and organising, there is emphasis on the science aspect of management whereas direction (including communication, leadership and motivation), co-ordination and control give emphasis on art aspect, like in leadership, a manager has to decide on the basis of his knowledge as to whether he wants to adopt autocratic or democratic or laissez-fair style.



But such a demarcation is unreal. In reality, the science and the art of management go together hand-in-hand and both are mutually interdependent and complementary. As theoretical teaching of medicine and engineering is always accompanied by practical work in a hospital or workshop, similarly in any aspect of management like planning, organising, directing, co-ordination or controlling, both the science and the art are present. This is so because the principles and theories are set before and the manager has to apply these principles by using his own abilities, judgement, intuition etc.

**3. Management is a distinct process :** It is well said that it is good management that produces sound business. This is because management is to business as mind is to human body. It is clear from the fact that understanding people, organising them into meaningful units, getting things done through them by managing conflicting goals and running the business smoothly, is something that makes all the difference.

Thus management as a process is best explained by the proverb, “management is what management does.”

The process of management includes the process of planning, organising, directing and controlling. These functions are separate but are part of the basic process of management activity.

Thus to see management as a process is to see all the basic functions as interwoven into one compact whole.

The entire process is basically a social one because it is the society in general which provides the input to the organisation and receives output from the same organisation which managers manage.

In this sense management as a process means:

- (i) It studies its internal and external environment.
- (ii) Through studies it organises its material and human inputs.
- (iii) Such an organisation and achievement of goals depend upon planning and decision-making process.
- (iv) After planning and organising, management has to design communication and control process to achieve desired results by eliminating undesirable hindrances.

Thus seen as a process, management is a group of activities systematically directed through time and space for achievement of goals.

Like all other processes, management process is continuous starting from a point and going through the various aspects and reaching at the same point to do it all over again and again. Old issues are solved and new ones crop up. Thus management seen from this is a process which is continuous and interlinked with the working of the organisation itself.

Scott & Mitchell in his book “Organisation Theory,” emphasises that management process is effective practical management of organisational process. They divide organisation process into subsets which are described as follows:

1. Communication process: How effectively does the management communicate.
2. Decision process: It is a vital process affecting all other processes.
3. Balance and Conflict process: It is the process showing how does the management manage the conflicts, in the organisation and create balancing among conflicting objectives.
4. Role and Status development process.
5. Influence of authority and power process.
6. Leadership process.
7. Technological process.



All processes have activities, changes and functions. These are elaborated as follows:

<i>Process</i>	<i>Activity</i>	<i>Change</i>	<i>Function</i>
1. Communication	Exchange of information among decision Centers information and control	To alter behaviour	Emotive motivation,
2. Decision-making	Quest for alternative action	To reduce uncertainty	Search alternatives
3. Balance	Organisation stability	To resolve conflict	Control
4. Role & Status	Interaction of authority	Modify role expectation	Clarification of rights & duties
5. Influence	Inducement to get things done	Achieve compliance	Authority, Power & exchange
6. Leadership	Directing, planning rewards and punishment	Alter attitude & behaviour	Authority, Feedback and Control
7. Technology	Selection of the best meant to accomplish the ends.	Rational-goal adjustment	Scientific methods and Verification

Thus management is a continuous process wherein well defined activities lead to effective and meaningful change in human behaviour to discharge its functions. Such a strategic process effectively link the organisation and make the management task effective and meaningful. Management thus is a dynamic process that underlies the internal life of an organisation with vital managerial functions.

**Summarising we can conclude:** Management is an activity or process for getting the work of an enterprise accomplished through the efforts of the people. This activity consists of planning, directing, communicating, co-ordinating and controlling as interlinked functions for effective management of this process which is aimed at goals' achievement.

**4. Management is universal in character :** If we look at management as a process, it is universal and applicable to all types of organisations. These may be economic, commercial, charitable, religious or political organisations. All have the same process and management has to effectively utilize them for goals achievement.

So management is an essential element of all social organisations and it is found everywhere as a distinct, separate and dominant activity; its nature does not change basically and materially due to change in the nature of the organisation.

As Urwick and Brech (Making of scientific management-vol.11) puts "No ideology, no 'ism,' no political theory can win greater output with less effort from a given complex of human and material resources, than sound management."

Briefly, the well being of the society is largely dependent upon the quality of management prevailing in all the social organisations.

**5. Management integrates human and other resources :** Of all, the human resources are the most precious and difficult to manage. Thus, a proper management of human resources is essential for the preservation and efficient functioning of an organisation in any society. For this purpose, it becomes the responsibility of well-trained managers to ensure the fulfilment of personal goals of individuals in order to bring these goals along the lines which contribute to the overall objectives of the organisation.

6. **Management aims at attaining predetermined goals** : Group efforts in management are always directed towards the attainment of predetermined objectives. These objectives are the final goals of any organisation towards which all the management activities are systematically and purposefully directed.

7. **Management is Intangible** : It is intangible in that it is a force which is invisible. Its presence is felt in the form of results, such as increased productivity, informed decisions, and increased morale of subordinates. Thus, feeling of management is manifested in the results accomplished. This point should not be confused with the persons (i.e., the visible team of managers) who use the management activities of planning, organising, staffing directing, and controlling to bring about these results.

8. **Management Utilises Multidisciplinary Approach** : Management, for the present vast body of its knowledge, has relied heavily on other fields, such as engineering, sociology, psychology, anthropology, etc. For example, productivity orientation drew its inspiration from engineering in so far as it emphasised the technical aspects of production. Human relations approach got its inspiration from psychology, and so on. Not only in the past, but at present also new developments in other fields are being increasingly utilised by management thinkers and practitioners. Research of psychologist in the field of individual motivation, reactions to authority, and the meaning and analysis of leadership has extended to the area of management only in recent years.

### **Management: A Profession**

With the emergence of management as a distinct discipline there is an increasing demand for its reorganisation as a profession. Some examples of professionals are doctors, lawyers, chartered accountants, etc.

A profession is a vocation that has some or all of the following characteristics :

- (i) Specialised education and training in an underlying body or organized knowledge, scientific outlook and intellectual bent of mind.
- (ii) Minimum qualification for admission to the question. Entry is restricted by examination or education and formalised method of acquiring training and experience is necessary.
- (iii) Continuous exchange of information and experience among the members of the profession to improve and increase the body of knowledge.
- (iv) A central organisation or association to regulate entry, to represent the profession and to regulate members' conduct.
- (v) A code of conduct enjoining upon the members to exercise self restraint in the practice.
- (vi) Service above self. Financial reward is not the measure of success. A professional spirit and a sense of mission are important.

If we judge on this criteria, management cannot yet be described as a profession though it has some of the characteristics of a profession. There is still no uniform method of entry and licensing. No minimum educational or other qualifications are essential for entry. The underlying body of knowledge is incomplete and inexact. There are no universal standards of competence and evaluation. The management associations have no legal sanction to enforce and administer minimum qualification. There is increasing exchange of views and experience through seminars and conferences. But there is little desire on the part of an average executive to develop the service of management. A uniform and binding code of professional conduct has not yet been developed and a sense of mission and dedicated service are not widespread. There is little autonomy of decision-making both in private as well as public sector.

However, management is moving at an increasing pace towards professionalisation. Many institutions now offer specialized training in different areas of management. There are various management consultancy firms which offer expert advice and guidance for the solution of management problems. Management is not yet a full-fledged profession. Whether or not, it becomes a profession in the near future, will depend upon the way managers develop a professional style of managing and the time they take for changing their outlook. In India, even a sense

of social responsibility is not widespread. Therefore, Indian management has to go a long way for becoming a profession. However, some thinkers, (for example, Drucker) are of the view that management should not strive towards professionalisation and there should be no statutory control over managers. The reason they give is that management is a practice rather than a science or profession.

Unlike a professional group, managers do not have a single group of clients. They are appointed by the owners/shareholders. But they are expected to serve not only their employers but also the workers, the consumers and the society at large. They have to be loyal to more than one group of persons.

There are some factors which are likely to increase the movement for the professionalisation of management. Some of such factors are separation of ownership from control, increased government regulation, growth of business activity, increase in trade union movement, desire of business leaders for social status and the development of scientific management.

## Principles of Management

As all processes need principles, so does management.

Principles are like code, to be followed for efficient performance. These are the essence of research. Principles are laid down after careful analysis of the working. These are just like the guide lines for effective performance which are indispensable for any organisation.

Henry Fayol (in General and Industrial Management) observed, “This (Principles of management as a code) code is indispensable. Be it a case of commerce, industry, politics, religion, in every concern there must be principles.” Even otherwise, those persons are respected who observe certain principles in life.

Following are the principles of management as laid down by Henry Fayol:

1. **Division of work:** In a large organisation, specialisation is the key to increased quality production. Thus division of work according to capacity, ability and aptitude is essential.
2. **Authority and responsibility:** Well defined responsibility gives maximum smoothness in work. The task of top management becomes easier and accountability possible, if responsibility is well defined. Without authority, responsibility cannot be fulfilled. So authority, its decentralisation and delegation is important for fixing responsibility. Authority should be linked to official position and responsibility stemming out of it.
3. **Discipline:** It is a distinctive feature of command. No co-ordination of work is possible and no responsibility meaningful without discipline. The requisites of discipline are (a) good supervision (b) clear and fair agreements on codes of conduct (c) judicious application of rewards and punishments.
4. **Unity of Command:** Command must emanate from one source. If there are multiple commanding authorities, it will create chaos. Thus, this principle means that an employee should receive orders from one superior only.
5. **Unity of Direction:** It is concerned with functioning of the whole corporate organisation. It means that there should be one head and the directions must flow downward.
6. **Subordination:** Individual goals should be subordinated (or aligned) to the organisational goal. Obedience to superiors is also a distinctive feature of command, which comes from subordination.
7. **Remuneration:** It should be fixed for all services or personnel to avoid uncertainty and ambiguity.
8. **Centralisation:** Every thing which goes to increase the importance of subordinates role is decentralisation whereas everything which goes to reduce it is centralisation.” Centralisation is essential to avoid misunderstandings and delay.

9. **Scalar Chain:** It suggests that the employees should be bound in clear and well defined chain of senior subordinate relationships, called scalar chain. It is line organisation that depicts it.
10. **Order:** It requires everything well placed and a place assured for everyone. Absence of order means chaos. Its presence ensures stability and efficiency.
11. **Equity:** It is a combination of kindness and justice. All equals be treated as equals. It removes conflicts and ensures compliance and subordination.
12. **Stability of Tenure:** Stability of working period is essential to give confidence in the worker. Stability of tenure creates certainty and helps in effecting responsibility.
13. **Initiative:** The employees at all levels, should be given some freedom to the adopters of techniques and methods to accomplish their tasks. It will create initiative and enforce efficiency. It increases zeal and belongingness. Fayol advises managers to ensure as much initiative from employees as possible because it gives them a chance to utilise their skill and efforts to the maximum.
14. **Esprit de corps:** This principle is essential for team work. Organisation work is primarily team work.

These principles have been interpreted differently by thinkers and writers. Some principles have been given more importance than others.

## Functions of Management

Though many writers have defined the functions of management differently, they have been clearly and unambiguously defined by Koontz and O'Donnell. These are as follows:

1. Planning
2. Organising
3. Staffing
4. Directing and leading
5. Controlling.

1. **Planning:** It means determining in advance. It involves selecting objectives and the strategies, policies, programme and procedures to achieve them. Thus planning is the most important activity of management that gives a thrust to all other activities. All other activities are based on it. Now people include forecasting also in managerial planning. It is so important that "all managers plan, whether at the top, middle or bottom of organisational structure." Planning is said to be the essence of management.

2. **Organising:** It involves establishment of internal organisational structure. It lays down line and staff relationships. It lays down role and status. It also involves grouping of activities, assignment of these groups of activities to managers, the delegation of authority to carry out activities and the provision of formal structure.

The following are the characteristics of organising function:

1. It requires groups of people.
2. It involves delegation of authority.
3. It lays down a formal structure of hierarchical relations.
4. The structure is a tool of obtaining organisation goals. So roles are specifically and clearly defined.

3. **Staffing:** It includes filling the places in organisational structure. It includes not only selection and training of personnel but also putting them in right positions. It involves manning and keep manned the positions provided in organisation structure. It thus requires defining manpower requirements, selecting candidates, training them and looking after them and the activities they perform.

4. **Directing and Leading:** It is a very crucial function as it involves motivation and leadership. Getting the work done through and with human beings is not easy. It involves achievement of organisation goals by subordinating or satisfying individual goals. According to Koontz & O'Donnell 'Super managers inculcate in their subordinates a keen appreciation of enterprise functions, objectives and politics — the superior has responsibilities for classifying their assignments guiding them towards improved performance and encourage

them to work with zeal and confidence.

5. **Controlling:** It involves ensuring the smooth functioning and good health of the organisation. It is a measure of actual performance with budgeted and taking corrective actions wherever necessary. Thus it measures performance against goals and plans; shows where negative deviations exist and by putting-in correct action ensures accomplishment of plans and objectives.

Thus, controlling is constant and continuous. It can control not only the activities and processes but also the people who achieve them.

## Management and Administration

Many people and organisations think management and administration as distinct functions, many others, and modern among them, feel that these are not different.

Management is a technical activity of getting goals achieved through people. In business institutions it is called management, while in others it is called administration.

Newman defines administration as, “the guidance, leadership and control of the effort of a group of individuals towards some common goal”. Sheldon defines Administration as, “that function in the industry which is concerned with determination of policy, consideration of finance, production, distribution and ultimately controlling the activities for accomplishment of objectives.”

It is clear from the above definitions that policy making, planning and decision making are the basic aspects of administration whereas their supervision, implementation and operation are the tasks of management.

These two functions are so interlinked that now thinkers call them as the administrative functions and operative functions of management.

According to Kaith Davis, both are aspects of the same activity which is defined as a process of getting things done to achieve the goals.

(1) Administrative management is the major function of top management. It is concerned with decision making and problem solving.

(2) Operational management is management as such. It is a function of the lower level management. It concerns with operative aspects such as supervision and control.

The flowing diagram clearly brings out this distinction between Administration (administrative management) and management (operative management).

(1) The top management such as the President, Vice-President etc, are more concerned with decisions and policy making aspect of management activities and less with the day-to-day supervision and control.

(2) The lower layers of management are less concerned with decision making (Admn.) and more with effective supervision and control.

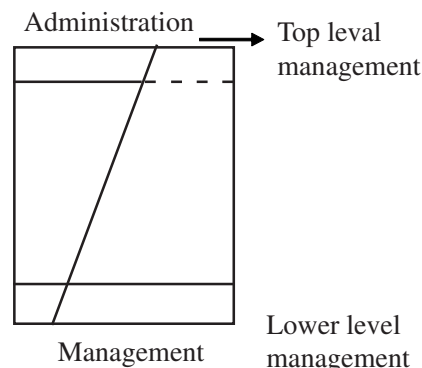

Thus administration has to lay down objectives, decisions and policy while the operative management strives to get them accomplished. So administration is more pronounced or applicable at higher level while management is more pronounced at the lower-level.

### **Emergence of Management Thought: Traditional v/s Modern**

Management as a science as well as an art has gathered momentum and velocity in the post industrial revolution era. This is because the size and complexities of organisation have increased tremendously. Moreover the ownership has been separated from management. It is this reason why management as a process has received wide attention.

**Traditional thought (Scientific Management):** Though management had been taken up as a subject quite early yet it was systematically studied by the classical writers. This may be called scientific management wherein research studies have been evolved to guide management activity. Though early writers in this field were James Watt, Mathew, Robinson, Robert Owen, Charles Babbage and others, yet the pioneering effort was made by Henry Fayol and Frederick Taylor.

F. Taylor laid down principles for the most efficient use of resources. He is thought to be the father of Scientific Management. He started as a machinist and rose to the position of chief engineer.

### **Principles of Scientific Management**

According to Taylor “in essence management involves a complete mental revolution on the part of the working man engaged in any particular establishment or industry—a complete mental revolution—proven to do their duties towards their work followmen and employers. It involves a complementai revolution on the part of management, the board of directors & owners.”

Fundamental principles of scientific management as enunciated by Taylor are:

- (1) Replacing Rules of thumb with science.
- (2) Obtaining harmony in group action.
- (3) Achieving co-operation.
- (4) Working for maximum outputs.
- (5) Development of the most efficient norms and system of doing work with minimum of effort and cost.

Thus, scientific management aims at finding the best way of doing things. It aims at evolving techniques of setting norm for group efforts.

### **Henry Fayol**

He is known as the father of Modern Occupational Management. He studied the business organisations in depth. He wrote as a practical manager. He laid down 14 principles of management and organisation as discussed earlier.

He emphasised that there are many activities common for all organisations. So these principles could be applied universally.

### **Management as a Behavioural Science**

As Taylor and Fayol were concentrating on Scientific management, others were looking at its human side. They included thinkers such as Lillian Gilbreths, W.D. Scott and others. The principles underlying human relations approach are as under :—

- (1) The management has to work with and through people. So it is human (and not only scientific) approach that helps in improving efficiency.
- (2) Individuals are related informally among themselves (Informal Organisation) along with formal organisation. So the management should take note of this informal organisation also.
- (3) Group behaviour is different from individual behaviour. Elton Mayo (in Hawthorne Studies) found out that workers resort to group norms.
- (4) Understanding industrial Psychology and human Psychology of the workers is very important.
- (5) Communication (both upward and downward) has very important role in organising business and its men.

### **Modern Management—Systems Approach**

Modern thinkers and writers consider management as a system. The early school of thinking evolved around the ideas of introduction of science and art of managerial functions, analysis of and experimenting with the psychological aspect of people working there.

The essential elements of systems approach to modern management is summarised below :—

1. Management is a system in itself. It takes inputs from the environment, works itself to transform them and get specific goals.
2. It has its own sub-systems which are meaningfully connected to make it a working whole. Its sub-systems are the various human, material, and social groups working together. Thus, it has its physical system, technical system and social system.
3. It is itself a part of the larger social system alongwith other systems such as the political system, the legal system, etc.

Thus in the systems approach to management, it is viewed as a complete system in itself having its own sub-systems. These sub-systems are not isolated. All are interlinked and work together for efficient functioning of the management. Management itself is a subsystem of the organisation. The other subsystems with which it is related in the organisation are the technical, marketing, production and finance etc.

\*\*\*\*\*



## LESSON 2

---

# MANAGERIAL PLANNING

---

Planning is the most fundamental function of management. An organisation can succeed in effective utilization of its human, material and financial resources only when its management decides in advance its objectives and methods of achieving them. If group effort is to be effective, people must know what they are expected to accomplish. This is the function of planning. Planning involves selecting from among alternative future courses of action for the enterprise as a whole and for every department or section within it. It requires selecting enterprise objectives and departmental goals and determining ways of achieving them. In this sense, plans provide a rational approach to preselected objectives. Planning also implies managerial innovation.

Planning is deciding in advance the objectives of the organisation in the short as well as long run, and the means of attaining them. Thus, planning bridges the gap from where we are to where we want to go. It makes it possible for things to occur which would not otherwise happen. Although it is extremely difficult to predict the exact future and although there are some factors which are beyond our control and they may interfere with the best-laid plans, but without plans, we are leaving events to chance. In other words, planning is an intellectually demanding process as it requires conscious determination of course of action and basing our decisions on purpose, knowledge, and considered estimates.

Planning is deciding in advance what to do, how to do, when to do and who is to do it. So we can say that elements of planning can be :

1. **What will be done**—Here objectives of business are to be decided in the short as well as in the long run.
2. **What resources will be required**—This involves estimation of available and potential resources, estimation of resources required for the achievement of objectives, and filling the gap between the two, if any.
3. **How it will be done**—It comprises two things (i) determination of tasks' activities, projects, programmes etc., required for the attainment of objectives, and (ii) formulation of strategies, policies, procedures, methods, standards and budgets for the above purpose.
4. **Who will do it**—It involves assigning the responsibilities to various managers for attaining enterprise objectives. These enterprise objectives are further broken down into segmental objectives resulting into divisional, departmental, sectional and individual objectives.
5. **When it will be done**—It consists of determining the timing and sequence, if any, for the performance of various activities.

### The Nature of Planning

The nature of planning can be understood by examining its four major aspects :

1. **Contribution of planning to accomplishing purpose and objectives of the organisation:** The purpose of every plan and all its supporting plans is to contribute to the attainment of enterprise purpose and objectives.

2. **Primacy of Planning:** Planning logically precedes the performance of all other managerial functions as in other managerial functions like organising, staffing, directing and controlling, operations are designed to support the accomplishment of the planned enterprise objectives. Although, in practice all the functions mix up, planning is unique as it involves establishing the objectives necessary for all group efforts. It is, therefore, necessary for a manager to plan in order to know what kind of organisation relationships and personal qualifications are needed, how subordinates are to be led and what kind of control is to be executed. Moreover, all the other managerial functions too should be planned if they are to be effective. Planning and control are dependent on each other. The reason is that any attempt to control without plans is meaningless as there is no way for the people to tell whether they are going the right way unless they first know where did they want to go. Therefore, plans furnish the standards for control.
3. **Pervasiveness of Planning:** Planning is a function of all managers. It is the responsibility of every manager to set his goals and operating plans. In doing this, he formulates his goals and plans within the framework of the goals and plans of his superior. Thus, planning is not the responsibility of the top management or the staff of planning department only. It is the responsibility for all those who are responsible for the accomplishment of results. Here it should be considered that planning acquires greater importance and tends to be longer in the future at higher than at lower management levels.
4. **Planning is a continuous process:** A plan means a statement of future intentions relating to objectives and means of their attainment. So, planning deals with the future, and future by its very nature, is uncertain. Plans cannot be said as final because revisions are required to be made in them in response to changes taking place in the internal as well as external environment of the enterprise.
5. **Plans are arranged in a Hierarchy:** First of all, plans are laid down for the entire organisation and they are known as corporate plans. This plan works as a framework for the formulation of divisional, departmental and sectional goals. Each of these organisational components sets its plans laying down the programmes, projects, budgets, resource-requirements, etc. The plans of each lower component are aggregated into the plans of successively higher component until the corporate plan integrates all component plans into a composite whole. For example, in the production department, each shop superintendent sets his plans, which are successively integrated into the general foremen's plans, works manager's plans and production manager's plans. All departmental plans are then integrated in the corporate plan. Thus, there is a hierarchy of plans consisting of corporate plan, divisional/departmental plans, sectional plans, and individual manager's unit plans. This can be shown as follow:

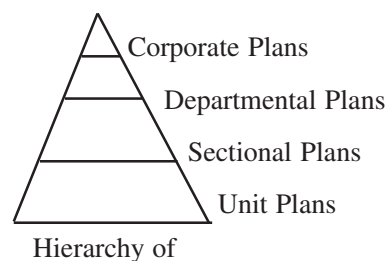

6. **Efficiency of plans:** The efficiency of a plan is measured by comparing its contribution to the organisational purpose and objectives with the costs and other factors required to formulate and operate it. Plans are efficient if they achieve their purpose at a reasonable cost, when cost is measured not only in terms of time or money or production, but also in the degree of individual and group satisfaction as well.

## Objectives of Planning

In an organisation, planning is important in the following manner:

1. **To Offset Uncertainty and Change:** Uncertainty and changes of future make planning a necessity. Future is uncertain to the extent it is not known. Planning is based on estimate of the future which enables the management to anticipate opportunities and challenges. It makes necessary changes in its technology, products, policies, strategies and practices to take maximum advantage of new opportunities, and minimise its losses caused by favourable situations.
2. **To Focus Attention on Objectives:** Because all planning is directed towards achieving enterprise objectives, the very act of planning focuses attention on these objectives. All the activities are performed to achieve those objectives. However, planning makes these objectives more concrete and tangible by focusing attention on these.
3. **To make Economical Operation Possible:** Planning minimises costs because of its emphasis on efficient operation and consistency. The reason is that planning involves the selection of most profitable course of action that would lead to the best results at the least costs. By providing consistency and balance in the efforts, planning introduces continuous and even flow of work without any friction or loss of energy.
4. **To Facilitate Control:** Managers cannot check on their subordinate's accomplishments without having planned goals against which to measure. Planned objectives and its instruments including policies, procedures, methods, standards, budgets etc., serve as instruments of control. Objectives provide the overall criteria for measuring performance. Policies provide the basis of evaluating decisions, and standards provide measures of efficiency of operations. Budgets provide the basis of financial control. Thus, planning serves as a basis of coordinated operations as well as control.
5. **To Increase Organisational Effectiveness:** Planning promotes efficient utilisation of organisational resources in many ways. It provides a basis for the allocation of resources among programmes, projects and activities. Budgets, methods and standards promote maximum utilisation of resources and minimise cost. Procedures and rules also save time and effort by regulating random behaviour and systematising the process of performance of activities.
6. **To help in coordination:** Though all the managerial functions lead to the coordination in the various units of the organisation, it starts at the planning stage. Well-considered overall plans unify inter-departmental activities and consequently restrict the area of freedom in the development of purely departmental plans. Thus, various departments work in accordance with the overall plan so that harmony is achieved.
7. **To provide criteria for decisions:** Strategies and policies provide criteria for decision-making. They also provide freedom to managers by specifying the limits within which they can exercise discretion in making decisions.

## Limitations of Planning

Planning is a difficult and complex process which itself is its limitation. Management can, however, improve planning effectiveness by recognising its limitations. Major limitations of planning are:

1. **Uncertainties of future:** As future cannot be predicted accurately, the forecasts and premises underlying the plans are subject to error.
2. **Expensive and time consuming:** Planning involves expenditure of financial, physical and human resources as well as time. This may delay action in certain cases. But it is also true that if sufficient time is not given to the planning process, the plans so produced may prove to be unrealistic.

3. **Internal inflexibility:** Internal inflexibility in the organisation may compel the planners to make rigid plans. In turn, managers may not like to take initiative and innovative action.
4. **External Factors:** Sometimes the effectiveness of planning is limited because of external factors which are beyond the control of the planners. For instance, government control, war, labour laws, Companies Act, natural factors like earthquakes, etc., may make the implementation of plans very difficult.
5. **Administrative problems:** These problems do not help in the creation of an environment which is conducive to planning. Some executives seem to think that planning is useless because the future cannot be predicted accurately. Conflict between staff planning specialists and line executives is also common factor which further complicates the process of planning. Planning also requires a participative style of management which would encourage involvement of managers and non-manager in the process of formulation of plans. Without this involvement, it is difficult to secure the full cooperation of those responsible for execution with the result that plans may remain on papers only.

The above problems do not, by any means, reduce the importance or need of planning. Recognising these limitations will help managers in more careful and systematic planning.

Some of the above limitations of planning can be over-come by taking the following measures:

1. The management information system should be properly organized so that all the relevant facts and figures are made available to the planners before they make any plan.
2. A system of forecasting together with a keen insight into the dynamics of future environment will improve the reliability of planned projections and estimates.
3. Management should give sufficient time and attention to planning as it is the basis of every other managerial function.

## Process of Planning

The planning process involves the following steps:

1. **Perception of opportunities**—This implies that management should take a preliminary look at possible future opportunities and see them clearly and completely. It should also know its standing in the light of its strengths and weaknesses. Besides, it should understand the reason for solving uncertainties and the outcomes which it expects. Setting realistic objectives depends on this awareness of opportunities.
2. **Establishing objectives**—In the planning process, the second step is to establish objectives for the entire enterprise and then for each subordinate work unit. Objectives imply the expected results and indicate the end points of what is to be done, where the primary emphasis is to be placed, and what is to be accomplished by the network of strategies, policies, procedures, rules, budgets and programmes.

Many plans of the enterprise are directed by enterprise objectives. These major plans define the objectives of every department by reflecting the objectives of the enterprise. The objectives of subordinate departments are controlled by the objectives of major departments and so on. However, the subdivision managers should be given an opportunity to contribute their ideas for setting their own goals and those of the enterprise. By doing this, the objectives of the concern and of departments can be framed in a better way.

3. **Establishing planning premises**—Planning premises are the various factors that affect planning. There are various factors which affect the organisational functioning like political factors, moral standards, government controls, prices, demand and availability of various factors of production. The important thing is that information is to be collected in respect of all these factors. Thus it can be said that planning premises are forecasts or the assumptions about the environment in which the

plan is to be carried out. It is important for all the managers involved in the plan to agree on the premises. This agreement is necessary for coordinated planning.

A difficulty of establishing complete premises and keeping them up-to-date is that every major plan, and many minor ones, become premises for the future. As we move down the organisation hierarchy, the composition of planning premises changes to some extent. The basic process is the same, but old and new major plans will affect significantly the future against which managers of lesser units must plan. For instance, a superior's plans affecting a subordinate manager's area of authority become premise for the subordinate manager's planning.

4. ***Determining alternative courses of action***—An action can be performed in several ways. However, a particular way is the most suitable for the organisation keeping its limitations in view. The management should try to find out these alternatives. The common problem is not in finding alternatives, but in reducing the number of alternatives so that the best possible ones may be analysed. Even with mathematical techniques and the computer, there is a limit to the number of alternatives that may be thoroughly examined. So the planner must usually make a preliminary examination in the light of planning premises to discover the best possible course of action.
5. ***Evaluating alternative courses***—After finding out alternative courses and examining their strong and weak points, the next step in the planning process is to weigh them in the light of premises and objectives. But this step possesses a difficult problem because a particular alternative may be the best from one point of view but not from other points. For instance, one course may appear to be the most profitable but require a large cash while another may look less profitable but involve less risk. Because of these complexities, the operation research and mathematical and computing techniques have their primary application in evaluating these alternatives.
6. ***Selecting a course***—After evaluating the various alternatives the most fit alternative is selected. To this course of action is the point at which the plan is adopted. It is the real point of decision making. Sometimes an evaluation of alternative courses may disclose that two or more are advisable. Here the manager may decide to follow several courses rather than the best course.
7. ***Formulating derivation plan***—After deciding the course of action or in other words the basic plan, the next step is to derive supporting plans for various departments, units, activities, etc.
8. ***Numberising plans by budgeting***—After decisions are made and plans are set, the final step is to numberize them by converting them into budgets. The overall budget of an enterprise show the sum total of income and expenses, with resulting profit or surplus and budgets of major balance sheet items such as cash and capital expenditures. Each department or programme of a business can have its own budget, usually of expenses and capital expenditure, which are then tied into the overall budget.

If this step is carried out properly, budgets can support the various plans and also serve as standards against which planning progress can be measured.

## **Types of Plans**

Enterprise objectives form the basic plan of a firm. Other types of plans are discussed below:

1. **Strategies:** A strategy may be defined as any decision or behaviour which takes into account the probable or actual actions, policies and strategies of competitors, suppliers, government, trade unions, etc; and aims at achieving organisational goals. The strategist looks to rivals and other external factors, existing strategies and behaviour, consider their probable counter-strategies in response to his various alternative strategies and selects the one which is likely to be most effective. For example, marketing strategy of one enterprise may be to compete on the basis of price and of another on the basis of quality.

An executive selects strategies that help him in attaining his goals, and creating for him an advantageous position in dealing with the socio-economic environment in which he has to operate, with a consequent reduction in risk and uncertainty.

Moore differentiates between three types of strategies:

1. **External Economic Strategies**—These deal with the broad approaches to meet the competition, adoption of technological changes responding to conditions of suppliers of raw materials, tools, equipment etc.
2. **External Social Strategies**—These are concerned with the company's way of dealing with government agencies, social and public welfare organisations, political parties and the community.
3. **Internal Organisational Strategies**—These relate to company's approach to the most effective utilisation of its existing human, physical and financial resources, development of potential resources, and generation of new resources.

Here it is important to distinguish between strategies and policies. Strategies focus on action and imply development of resources for their implementation, whereas, policies provide a guideline for decisions and action. For example, the marketing strategy of the Bata Shoe Company now is to use its own distribution network as also exclusive dealers for selling the Bata brand shoes while other dealers can deal in BSC and other brand shoes, its pricing policy is to mark all prices in "rupees and paises."

**2. Policies:** Policies are a guide to decision making. They establish the broad framework with which managers operate at various levels and are engaged in various functions, make decision of a recurrent nature. Policies also set limit within which the decision maker can operate. Policies do not tell a manager what he should do or how he should act in specific situations. They tell him what he can do, and thus set the limits to his decisions.

**Formulation of Policies.** Policies are formulated by executives at various levels in the organisation. Top management policies relate to major areas which are of strategic importance for the organisation as a whole. The owners of the enterprise lay down policies in regard to the nature and purpose of the business. The board of directors and the top management formulate basic policies of the company within the framework of the owner's policies. The basic policies relate to strategic areas of the company's business such as policies for capital investments, policies relating to wages and salaries, bonus and other benefits, dividend policy, pricing and distribution policies, and so forth. These policies are basic to the enterprise and provide direction to all its decisions.

Top management policies provide the basic framework for the formulation of derived policies for every division, department and function of the company. For instance, advertising and sales promotion policies are formulated by the marketing manager within the framework of top management policies relating to product-line, distribution channels and pricing.

At the lower levels of the organisation, the first line supervisors, section heads, etc., formulate policies for the performance of their own functions within the framework of the policies of their higher organisational units.

**Purpose of Policies.** Policies aim at :

1. Providing guidance to decision making on problems of a recurrent nature.
2. Channelising all decisions towards the achievement of predetermined goals.
3. Providing criteria for evaluating decisions.
4. Ensuring consistency and uniformity in decisions throughout the organisation.

**Principles for the formulation of Policies**—The following principles are applicable to the formulation of policies:

1. Policies should aim at contributing to the achievement of the objectives of the enterprise.



2. Policies should be definite and in writing.
3. Policies should be stable and flexible.
4. Policies at each lower level in the organisation should be derived from the policies of its immediately higher level.
5. Policies of each department and functional head should be coordinated with the policies of all other departments and functions.
6. Policies should be just, fair and equitable.
7. Policies should be periodically reviewed and modified, if necessary, to cope with the changing needs of the organisation.

**3. Rules:** Rules are a guide to action. In contrast, policies are guides to decisions. Rules prescribe behaviour, and define what should and what should not be done. “No smoking”, ‘wearing of safety-glasses while working at welding machines’, are examples of rules. Rules are often accompanied by a penal clause for non-compliance. For example, a rule on attendance may state that, “if an employee is late at work for three days in a month, he shall lose one day’s casual leave.” Rules have the benefit of regulating and predicting behaviour in an organisation, but at the same time restrict initiative.

Rules should be distinguished from policies. The purpose of policies is to guide decision making by marking off areas in which managers can use their discretion. Although rules also serve as guides, they allow a manager discretion in their application.

**4. Procedures:** Procedures are plans that establish a required method of handling future activities. Procedures lay down the sequence of activities that several individuals should undertake to accomplish a specific goal. Procedures are steps involved in the transaction of the company’s business. For example the procedure for hiring new personnel may involve creation of the post by the competent authority, preparation of job description and job specification, requisition by the departmental head to the central personnel department, advertisement of the post, scrutiny of application, administration of selection tests, hiring decision by the competent authority, issuing of the appointment order and medical testing of the new employee. Each of these steps must be completed in a sequential order.

Whereas policies are guides to decisions and rules are guide to action, procedures are the sequence of steps involved in making decisions and performance of activities.

**5. Programmes:** Programmes relate to those activities which have distinctive mission and time schedule. They generally cover some special activity which is a part of corporate planning. Some examples of activities for which programmes are prepared for execution are plant expansion, promotion of a new product, opening of a new sales branch, etc. In other words, programmes are a means of achieving some desired result within the scheduled time.

Programmes involve following steps:

- (i) Identification of activities needed for its execution, for instance, ordering the equipment, selection of site etc.
- (ii) Identification of sequential order of various activities specifying which activities are to follow, precede or start simultaneously in relation to one another;
- (iii) determination of starting and completion time for each step;
- (iv) determination and arrangement of physical, financial and material resources required for implementation;
- (v) assignment of responsibility for the execution and completion of each step leading to the completion of the programme; and
- (vi) establishment of a control system with respect to cost, time and quality of work performance.



**6. Budgets:** Budgets are the most wisely used instruments of planning as well as control. A budget is a statement of expected results expressed in numerical terms. Budgets are often called “numerical plans” as they are quantitative in nature. Financial budgets, also called “profit budgets”, are an estimate of revenue and expenditure for one year. Capital budgets relating to new investments in product diversification, plant expansion, etc., may extend over a period of more than one year. They are financial plans of anticipated results in terms of profit represented by an excess of revenue over expenditure. Non-financial budgets include man power budgets, performance budgets, materials budgets, sales budgets, direct-labour hours budgets, etc.

Budgets are also control devices. But a budget cannot serve as a good standard of control unless it reflects plans. However, making a budget is clearly planning. Details of budgets are dealt in the lesson on control.

\*\*\*\*\*

## LESSON 3

---

# NATURE AND PROCESS OF ORGANISING

---

Organising is one of the major functions of management. It consists of identifying and grouping of activities, assigning of authority to managers and providing for coordination.

Every organisation is created with a set of purposes. For achieving these purposes, we must first of all, determine what activities will have to be performed. For example, before the organisers of a hospital can help the sick, they will have to determine what equipment to buy, how many doctors, nurses and other staff to hire, how many departments to create, and so on. In other words they have to first decide about the total work to be done for achieving the hospital's objectives. Thus, organising process begins with the detailed enumeration of various activities that will have to be performed for achieving the organisational goals.

The second step in the organising process is to group various activities in some meaningful way. It is useful to put activities of a similar nature in one group. Generally, various activities are grouped in different departments. The grouping of activities in accordance with the functions of an enterprise is a widely accepted practice. In a manufacturing concern, sales, production, personnel and finance are some of the typical departments. One important feature of grouping various activities into departments is that activities in one department happen to be clubbed together because of their essential similarity and contrast with the activities of other departments because of their dissimilar nature. Thus, the second step in the organising process is to group various activities into departments.

The third step in the organising process is to assign each department to a manager with authority necessary to supervise it. This is the most important step in the organising process because nothing systematic happens in an organisation unless every one knows what is expected of him, what authority he has and to whom he is accountable. This aspect of organising is known as delegation. A manager, because of his limited physical and mental capabilities, cannot do all the work himself. He keeps a part of the total work with himself and delegates the other part to his subordinates. These subordinates have to be given adequate authority so that they can discharge their responsibilities satisfactorily. At the same time they have to be made accountable to the manager so that he may account for the tasks entrusted to him by his superior. Thus, the three elements of delegation, namely, authority, responsibility and accountability constitute a very important part in the organising process.

The fourth and the final step in the organising process is to provide for horizontal and vertical coordination in the organisation structure. As individuals and departments perform their assigned tasks, the overall goals of the organisation may become submerged or conflicts among organisation members may develop. For example, marketing manager may press for larger advertising budgets to stimulate demand even though the larger interests of the organisation may be best served by investment in automatic machinery for reducing the cost per unit. To prevent such a situation it is necessary to establish coordination between the production and the marketing departments. Such a coordination is known as horizontal coordination. Vertical coordination between the different levels of organisation is also necessary for its smooth functioning.

### PRINCIPLES OF ORGANISING

Let us now discuss the principles of organising. These principles are more in the nature of criteria for good organising than any hard and fast rules which must be followed while organising any structure. It is important to

note that there can not be any one best organisation structure suitable for all organisations or for all times. Following are some of the important principles of organising:

**1. Unity of Direction:** This principle implies one head and one plan for a group of activities having the same objectives. Unity of direction is achieved when every department and section attempts to specialize in the activity assigned to it.

**2. Unity of Command:** This principle states that a subordinate reports only to one boss. This is necessary to avoid conflict which may develop if the subordinate receives conflicting orders from more than one boss.

**3. Authority:** Every individual in an organisation has some responsibility which he can discharge properly only when authority granted to him is in accordance with his responsibility.

**4. Span of Control:** Span of control refers to the number of persons which a manager can effectively supervise. According to this principle, the span of control must be limited because the physical and mental capabilities of a manager are rather limited.

**5. Flexibility:** The organisation structure must be sufficiently flexible to accommodate changes occurring within and outside an organisation.

**6. Management By Exception:** This principle requires that organisation structure should be so designed that managers are required to go through only the exceptional matters. All the routine decisions should be taken by the subordinates, whereas problems involving unusual matters and policy decisions should be referred to the managers.

**7. Scalar Principle:** According to this principle, there must be clear lines of authority running from top to bottom in the organisation structure. The clearer the line of authority from the top management to every subordinate position, the more effective will be the performance.

## Formal and Informal Organisation

The formal organisation is the outcome of the organising process. It is deliberately designed for achieving the organisational objectives. It specifies who is to be what, with whom and under whose supervision. Informal organisation, on the other hand, emerges spontaneously as a result of human interaction. When people interact, they develop likes and dislikes. As a result, they happen to find themselves as members of informal groups. Normally, these informal groups are not planned to come into existence. They evolve over time and influence the behaviour of their members to a considerable extent. The organisers should not try to suppress the growth and functioning of these informal groups which are merely expressions of shared sentiments or values. Rather they should try to utilise them for achieving the organisational objectives.

## Span of Control

There is limit to the number of persons a manager can effectively supervise. This limit varies depending on the situation. As a result of this limit, organisational levels come into existence. A wide span of control is associated with few organisational levels; a narrow span results in many levels.

In every organisation, it must be decided how many subordinates a supervisor can manage. The classical theory recommended specific numbers of subordinates—six at the top and twenty at the bottom. But a more recent view is that there are too many variables in a management situation to specify any particular number of subordinates which a manager can effectively supervise. There is a limit to the number of subordinates a manager can effectively supervise, but the exact number will depend upon underlying factors that affect the difficulty and time requirements of managing.

**Factors determining an effective span:** In searching for the answer as to how many subordinates a manager can effectively manage, we discover that—aside from such personal capacities as quick understanding, getting

along with people, and commanding loyalty and respect—the most important determinant is the manager’s ability to reduce the time he spends with his subordinates. This ability naturally varies from one manager to another, but there are seven general factors which significantly influence the number and frequency of superior-subordinate relationships. These factors are as follows:—

1. **Subordinate Training:** The better the training of subordinates, the less the time consumption and frequency of contacts with the manager. A manager can afford to have a wide span if the subordinates are well-trained.
2. **Clarity of Delegation of Authority:** Although training enables managers to reduce the frequency and extensiveness of time consuming relationships, the main cause of the heavy burdens of such relationships is to be found in lack of adequate authority and lack of clarity of delegation. A manager, who clearly delegates authority to undertake a well-defined task and delegates the required amount of authority, can get the job done with a minimum of encroachment on his time. But if the subordinates’ task is not clearly defined, or if he does not have adequate authority to perform the task, either the task will not be performed or the manager will have to spend a disproportionate amount of time supervising and guiding the subordinates’ efforts.
3. **Clarity of Plans:** If organisational plans are well defined, if they are workable, if adequate authority has been delegated to undertake them, and if the subordinates understand what is expected of them, little of a supervisor’s time will be required. On the other hand, where plans cannot be drawn accurately and where subordinates must do much of their own planning, their decisions may require considerable guidance.
4. **Use of Objective Standards:** A manager must find out whether his subordinates are following plans. He often requires standards against which he can compare the actual performance of his subordinates. If these standards are set objectively i.e., do not require subjective judgement, then manager’s job becomes easier and enables him to avoid many time-consuming exercises and relationships.
5. **Rate of Change:** Certain enterprises change much more rapidly than others. The rate of change is important in determining the degree to which policies can be formulated and stability of policies maintained. Slower the rate of change, broader the span can be had. However, if the rate of change is rapid, a narrow span would become necessary.
6. **Communication Techniques:** The effectiveness with which communication techniques are used also influences the span of control. If every plan, instruction, order, or direction has to be communicated by personal contact, a manager’s time will obviously be heavily burdened and he will not be able to supervise the work of too many subordinates. An ability to communicate plans and instructions clearly and concisely or comprehensively also tends to increase a manager’s span. The subordinate, who after leaving a superior’s desk or receiving instructions, is still in doubt as what is wanted or what has been said is sure to increase the meetings with his superior. As a result, his span of management will be reduced.
7. **Amount of Personal Contact Needed and other Factors:** In many cases, face-to-face meetings are necessary, these meetings obviously draw upon a manager’s time. Greater the number of such meetings, lower the span of management. Besides the listed factors, there are factors that influence the span of management. For example, a competent and trained manager can effectively supervise more people than one not having these attributes. Furthermore simple tasks allow for a wider span than tasks that are complex.

To sum up, we can say that there is a limit in each managerial position to the number of persons an individual can effectively manage, but the exact number in each case will vary with underlying variables and their impact on the time required for effective managing.

## Line and Staff Authority Relationships

Line and staff are viewed in various ways. One widely held concept of line and staff is that line functions are those that have direct responsibility for accomplishing the objectives of the enterprise, while staff functions are those that help the line to work most effectively in achieving the primary objectives of an enterprise. Those who subscribe to this view almost classify production and sales as line functions, and purchasing, accounting, personnel, plant maintenance, and quality control as staff functions.

Such a view is confusing. Staff functions are not really any less essential to the achievement of company's objectives. A more precise and logically valid concept of line and staff is that they are simply a matter of relationships. According to this view, line authority gives a superior a line of authority over a subordinate. This authority exists in all organisations. The nature of the staff relationship is advisory. The function of people in pure staff capacity is to investigate, research and give advice to line managers to whom they report.

The distinction between line and staff is important. Superior and subordinate alike must know whether they are acting in a staff or a line capacity. If in a staff capacity, their job is to advise and not command; in a line capacity, they must make the decisions and issue orders.

**A. Line Organisation:** An organisation structure consisting of line personnel only may be called a line organisation. In such an organisation, each position has general authority over all the lower positions (Fig. I).

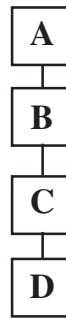

Figure I : Line Organisation

In a line organisation, as shown in the above figure, authority flows downwards in a straight line. No subordinate is under more than one superior. Scalar principle and the principle of unity of command are strictly followed.

**Advantages:** The main advantages of the line organisation are as follows:

1. It is simple to work. There are no staff positions.
2. It is economical and effective, for it permits of rapid decisions and effective coordination, as all the activities affecting the department are in the hands of one individual.
3. It makes for unity of command and also conforms to tasks in a definite manner upon the concerned individuals.
4. It fixes responsibility for the performance to tasks in a definite manner upon the concerned individuals.
5. It is conducive to effective control because a subordinate is answerable to only one boss.

**Disadvantages:** The system has the following drawbacks:

1. The system is not workable in large organisations.

2. It suffers from lack of specialisation. Each department manager has to buy his own materials, design his own product, engage his own labour, keep his own records, set his own standards of output and cost. Therefore, because of the lack of specialized skill each head of the department is inclined to be a jack of all trades and master of none.
3. The fixation of responsibility on the shoulder of the manager can crush under the load of too much work.
4. The system cannot reap or provide the benefits of expert advice of the staff personnel because it does not provide for their appointment.

**B. Line and Staff Organisation:** In line and staff organisation, line authority moves down in the same manner as in the line organisation. In addition, specialists are attached to line managers to advise them on important matters, as is shown in figure II.

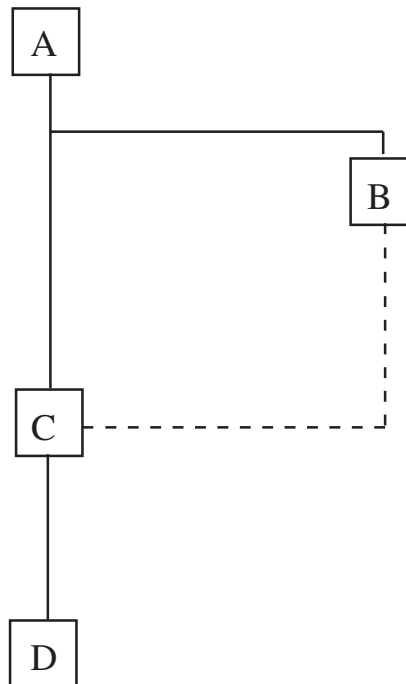

Figure II: Line and Staff Organisation

In Fig. II, A, C and D are parts of the chain of command. As far as the relationship of B to A is concerned, B is subordinate to A, but he is not a part of the chain of command. The relationship between B and C is just advisory in nature and B enjoys no authority over C. However, B may enjoy a higher status than C does, though the relationship between B and C is not that of superior and subordinate. Thus, those who develop ideas and render advice on various aspects of organisational functioning and fall outside the chain of command are staff personnel. Those who implement these ideas and form part of the chain of command are line personnel. Most organisations have both line and staff personnel and are, therefore, called line and staff organisations. We must, however, remember that even a head of the staff department enjoys authority in his own unit. He has line relationship with his subordinates and enjoys authority over them.

**Advantages:** The line and staff organisation has all the benefits of the line organisation. It has the following additional advantages:



1. Line managers get the benefit of specialized knowledge of staff specialists at various levels.
2. Staff specialists relieve the line managers from the botheration of concentrating on the specialized functions like accounting, selection and training, public relations, etc. and thereby enable them to do their work more effectively.
3. Staff specialists help the line executives in taking better decisions by providing them adequate information of right type at the right moment.
4. Line and staff organisation is more flexible than line organisation because experts can be appointed for helping the line personnel.

Disadvantages: Line and staff organisation suffers from the following drawbacks:

1. There is generally a conflict between the line and staff executives. Staff personnel may complain that their advice is not accepted by the line managers who in their turn, may complain that the staff personnel have only theoretical knowledge and don't understand the practical problems. Such a conflict is not good for organisational health.
2. Because staff personnel are not accountable for the results, they may not perform their duties properly.
3. Because the promotional avenues for the staff personnel are rather limited, they compete with each other to gain favour of the senior line officer. This promotes the cult of flattery and is highly undesirable. Moreover, in the event of any opportunity becoming available outside, the staff personnel are, without any hitch, prepared to leave the organisation. This is also undesirable from the point of view of the organisation.

**C. Functional Organisation:** One of the most important organisational principles is that a subordinate should receive command from and report only to one boss. If there are more than one boss for the same subordinate, he will be confused as to whose orders he should obey. This principle is called the unity of command principle. However, in modern organisations which are huge in size and highly complex, it is often seen that the same workers have to receive commands from more than one superior in different matters. It is just not possible for one superior to supervise the worker in respect of time scheduling, quality control, material handling, etc. Therefore, different superiors performing different functions command the same order in respect of their respective functions. Such an arrangement is known as functional organisation, as shown in Fig. III.

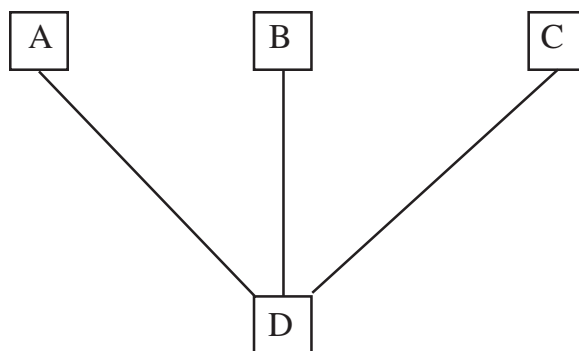

Figure III: Functional Organisation

It should be obvious from Fig. III that D receives command from A, B and C. This violates the principle of unity of command, but this violation has become necessary in view of the increasing size and complexity of organisations in which it is difficult for one supervisor to supervise in all matters. Therefore, in a functional organisation, a worker receives commands from different sources on different matters for his functioning. This is more clearly explained in Fig. IV:

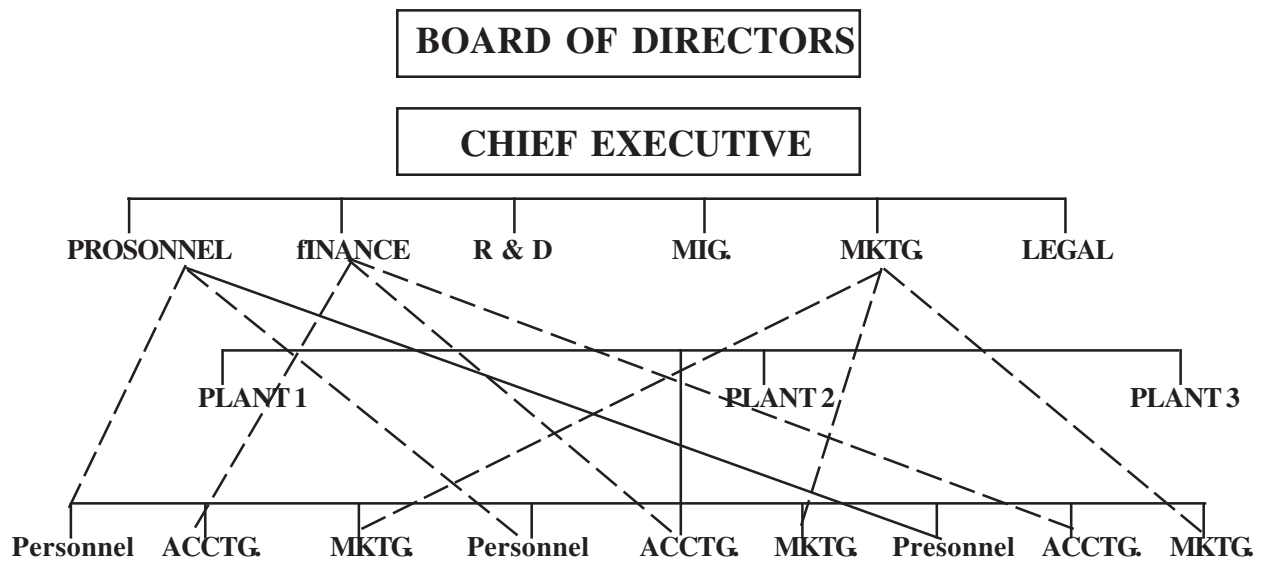

Figure IV. Functional Organisation

In Fig. IV one finds that personnel departments in all the three plants are being directed in personnel matters by the personnel department at the apex level. The personnel departments of various plants are also being controlled by the plant manager concerned. So is the case with all other departments in a particular plant. In this case, the line authority of plant managers is being shared by the functional heads for respective functions at the apex level. This is because the benefit of expert knowledge of staff departments at the apex level becomes available to all the plants. Besides, it helps in maintaining uniformity of policies and procedures. For example, the personnel manager of the plant is accountable to the plant head for personnel problems of the plant, but he is accountable to the personnel head at the apex level for implementation of personnel policies of the organisation.

**Advantages:** The functional organisation has the following advantages:—

1. It helps in achieving the benefits of specialisation of work, as one man devotes his entire time and energy in doing one thing.
2. Each person gives his best efforts which he develops according to his best abilities.
3. It makes supervision easier, because each manager is expert only in a narrow range of skills.

**Disadvantages:** Some of the drawbacks of functional organisation are:

1. Because of the failure to define the exact nature of the functional authority, the system proves confusing from the point of view of procedures of control.
2. The clear-cut lines of responsibility and authority of the line organisation are totally lost.
3. It complicates the control process by making the workers work under different superiors.
4. It makes difficult for the management to fix responsibility for unsatisfactory results.

### Delegation and Decentralisation

There is a limit to the number of subordinates a manager can effectively supervise. Once this limit is reached, delegation of authority becomes necessary. Delegation of authority is the most important step in the organising process.

To delegate means to grant authority to the subordinate to accomplish a particular assignment. Delegation enables a manager to distribute his work load to others and concentrate on more important functions which he

can perform better because of his organisational position. Delegation is the process which a manager follows in dividing the work assigned to him so that he performs that part which only he, because of his unique organisational placement, can perform effectively, and so that he can get others' help for whatever remains to be done.

Delegation of authority is widely recognised as an art of getting the best results. The process of delegation comprises the following three components:

1. Entrustment of responsibility (duty or work) to the subordinate for performance;
2. Granting of authority to make use of resources, take necessary decisions and so on for carrying out the responsibility; and
3. Creation of an obligation or accountability on the part of the person accepting the authority to perform in terms of the standards established.

Let us briefly discuss these components:

1. **Entrustment of Responsibility:** Responsibility means the work or duty assigned to a person. It arises from the superior-subordinate relationship. In order to enable the subordinate to perform his responsibility well, the superior must clearly tell him as to what is expected of him.
2. **Granting of Authority:** Authority is the right granted to an individual to make possible the performance of work assigned. Power to use resources, power to hire and fire people, power to take necessary decisions, etc., has to be delegated to individuals to whom the work is assigned.
3. **Creation of Accountability:** Once a subordinate is entrusted with responsibility to perform certain jobs and he is given sufficient authority to perform the assigned work, the final phase in delegation is holding the subordinate answerable to his superior for the actual results. Accountability is the obligation to carry out responsibility and exercise authority in terms of performance standards established. For accountability to be effective, the standards of performance should be determined before entrusting a task and should be understood and accepted by the subordinate.

The three components of delegation are like three legs of a stool. Each depends on the other two. If one leg is weaker or shorter, the stool of delegation will be unstable See fig. V.

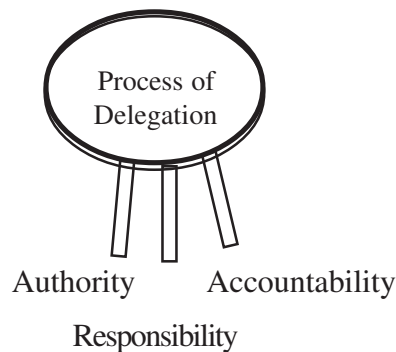

Figure V. Stool of Delegation

## Principles of Delegation

The following principles are guides to delegation of authority:

1. **Delegation by Results Expected:** This principle states that before delegating authority the manager should look first at the goals to be achieved and then delegate authority sufficient to achieve the expected results.

2. **Principle of Functional Definition:** This principle states that there must be clear definitions of results expected and activities to be undertaken. The more clear the definitions, the more adequately the individuals can contribute towards accomplishing enterprise objectives.

3. **Scalar Principle:** The scalar principle refers to the chain of direct authority-relationships from superior to subordinate throughout the organisation. Subordinates must have a clear idea as to who delegates authority to them and to whom matters beyond their authority must be referred.

4. **Authority-level Principle:** This principle states that decisions within the authority of individuals must be made by them and not be referred upward in the organisational structure. In other words managers at each level should make whatever decisions they can in the light of their delegated authority, and only matters that they can not decide because of limitations on their authority should be referred to superiors.

5. **Unity of Command:** This principle requires that an individual should report to only one superior to avoid conflict.

6. **Absoluteness of Responsibility:** This principle states that a manager who has delegated authority and assigned duties cannot escape his responsibility for the activities of his subordinates. This responsibility of the manager is absolute and cannot be delegated.

7. **Parity of Authority and Responsibility:** This principle requires that the amount of authority should correspond to the amount of responsibility. It should neither be more, nor less. According to this principle, managers should not hold their subordinates responsible for duties for which they have not been given the necessary authority.

**Advantages of Effective Delegation:** When used properly, delegation has several important advantages. The first and most obvious is that the more task managers are able to delegate, the more opportunity they have to seek and accept increased responsibility from higher-level managers.

Another advantage of delegation is that it frequently leads to better decisions, since subordinates closest to the actual operating level are likely to have a clearer view of facts.

In addition, effective delegation speeds up decision making. Valuable time is lost when subordinates must check with their superiors before making a decision. This delay is eliminated when subordinates are authorised to make the necessary decisions on the spot. Finally, delegation causes subordinates to accept responsibility and exercise judgement. This not only helps to train subordinates but also improves their self-confidence and willingness to take initiative.

## Barriers to Effective Delegation

In spite of the advantages, many managers are reluctant to delegate authority and many subordinates are reluctant to accept it. Both these barriers hinder effective delegation:

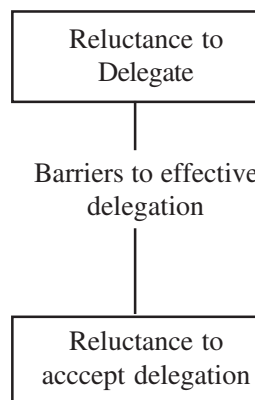

**Reluctance to Delegate:** There are a number of reasons that managers commonly offer to explain why they do not delegate: “I can do it better myself; “My subordinates are just not capable enough”; “It takes too much time to explain what I want to be done”. These reasons are often excuses that managers use to hide the real reasons.

Insecurity may be a major reason behind reluctance to delegate. Managers are accountable for the actions of subordinates, and this may make them reluctant to ‘take chances’ and delegate tasks. Or the manager may fear a loss of power if the subordinate does too good a job.

An additional case of reluctance to delegate is a manager’s lack of ability. Some managers may simply be too disorganised or inflexible to plan ahead and decide which task should be delegated to whom or to set up a control system so that subordinates’ action can be monitored.

Lack of confidence in subordinates is a third major reason why managers avoid delegation. In the short run, this lack of confidence may be justified if subordinates lack knowledge and skill. In the long run, there is no justification for failing to train subordinates. Managers who lack confidence in their subordinates—perhaps because of an inflated sense of their own worth will severely limit their subordinates’ freedom to act.

**Reluctance to Accept Delegation:** Insecurity can also be a barrier to the acceptance of delegation. Some subordinates want to avoid responsibility and risks and would like their bosses to make all decisions. Similarly, subordinates who fear criticism or dismissal for mistakes are frequently reluctant to accept delegation.

Another common reason for reluctance is that subordinates may not be given sufficient incentive for assuming extra responsibility. Accepting delegation frequently means that they will have to work harder under greater pressure. Without adequate compensation subordinates may be unwilling to do so.

**Overcoming the Barriers:** The most basic prerequisite to effective delegation is the willingness of managers to give their subordinates real freedom to accomplish delegated tasks. Managers have to accept the fact that there are usually several ways to solve a problem and that subordinates may legitimately choose a path different from their own. And, subordinates will make errors in carrying out their tasks. But they must be allowed to develop their own solutions to problems and to learn from their mistakes. The solution to subordinates’ mistakes is not for the manager to delegate less, but to train subordinates more.

Improved communication between managers and subordinates will reduce mutual misunderstanding and thus help to make delegation more effective. Managers who know the abilities of their subordinates can more realistically decide which tasks can be delegated to whom.

A useful method for overcoming barriers to delegation is to reduce the complexity of delegated assignments and increase the degree of delegation over a span of time. Thus, a manager can delegate successfully more work and subordinates will accept more responsibility for particular tasks.

## **Decentralisation**

The delegation of authority by individual managers is closely related to an organisation’s decentralization of authority. Delegation is the process of assigning authority from one level of management down to the next. The concepts of decentralisation and centralization refer to the extent to which authority has been passed down to lower levels (decentralisation) or has been retained at the top of the organisation (centralisation). The greater the amount of authority delegated throughout the organisation, the more decentralised the organisation is.

The advantages of decentralisation are similar to the advantages of delegation: unburdening of top managers; improved decision making because decisions are made closer to the scene of action; better training, morale, and initiative at lower levels; and more flexibility and faster decision making in the changing environments. These advantages are so compelling that it is tempting to think of decentralisation as good and centralisation as bad.

But total decentralisation, with no coordination and leadership from the top, would clearly be undesirable. The very purpose of organisation-efficient integration of subunits for the good of the whole—would be defeated without some centralised control. For this reason, the question for managers is not whether an organisation should be decentralised but to what extent it should be decentralised.

**Factors Determining the Degree of Decentralisation:** The appropriate amount of decentralisation for an organisation will vary with time and circumstances. It will also vary for the different subunits of the organisation. For example, production and sales departments may afford a high degree of decentralisation, whereas financial departments may have to be comparatively centralised. In determining the amount of decentralisation appropriate for an organisation, the following factors are usually considered:

1. **Costliness of the Decision:** As a general rule, the more costly the action to be decided, the more probable it is that the decision will be made at the upper levels of management. Thus, quality control in drug manufacturing, where a mistake might endanger lives, to say nothing of the company's reputation, would normally report at a high level, while the quality inspection in toy manufacturing might report at a much lower level.

2. **Desire for Uniformity of policy:** Another factor favouring centralisation of authority is the desire to obtain uniform policy. Those who value consistency, above all, invariably favour centralised authority, since this is the easiest way to reach such a goal. They may wish to ensure that customers will be treated alike with respect to quality, price, credit, delivery, and service; that the same policies will be followed in dealing with suppliers; or that public relations policies will be standardized. Thus, a desire to have uniform policies will not permit of a high degree of decentralisation.

3. **Size of the Organisation :** The larger the organisation, the more decisions to be made, and the more places in which they must be made, the more difficult it is to coordinate them. The larger the size of an organisation, the greater the need for high degree of decentralisation.

4. **History of the Enterprise:** Whether authority will be decentralised frequently depends upon the way the business has been built. Those enterprises which expand from within, i.e., without manager or consolidation, show a marked tendency to keep authority centralised as do those which expand under the direction of their owner-founders. On the other hand, enterprises that result from mergers and consolidation are likely to show a definite tendency to retain decentralised authority. This is because of the desire of the merged units to retain their pre-merger independence.

5. **Management Philosophy:** The character and philosophy of top executives have an important influence on the extent to which authority is decentralised. Sometimes top managers are absolute rulers and do not tolerate any interference with their authority and information. Naturally, such managers can not be expected to believe in decentralisation of authority and the organisation will have a centralised structure. On the other hand, some managers believe, in a more democratic set up and hence in a decentralised structure. Thus, managers' character and their philosophy influence the extent to which authority will be decentralised.

6. **Availability of Managers:** A real shortage of managers would limit the extent of decentralisation of authority, since in order to delegate, superiors must have qualified managers to whom to give authority. But too often the scarcity of good managers is used as an excuse for centralising authority. Executives who complain about the scarcity of managers are often trying to magnify their own value to the firm. Thus, any shortage of managers—real or imagined—would limit the extent of decentralisation of authority.

7. **Control Techniques:** Decentralisation also depends on the availability of control techniques and the ability and willingness of managers to use them. Because some managers do not know how to control, they are unwilling to delegate authority. They may think that it takes more time to correct a mistake than to do the job themselves in the first place.

8. **Decentralised Performance:** Decentralised performances refers to the situation where the operations of an organisation are spread over a geographic area.



Authority tends to be decentralised when performance is decentralised. It does not follow that when performance is centralised, authority is centralised. But one thing is clear, decentralisation of performance limits the ability to centralise authority.

9. ***Environmental Influences:*** Some of the important external factors affecting the extent of decentralisation are governmental controls, labour unionism and policies.

Government regulation of business makes decentralisation difficult and sometimes impossible. If prices are regulated, sales managers cannot be given much real freedom in determining them. If materials are allocated and restricted, purchase managers' freedom will be restricted. If labour may be asked to work only a limited number of hours at a given rate of pay, the local division manager cannot freely set hours and wages.

Similarly, labour unions at the national level tend to have a centralising influence on business. So long as department managers can negotiate the terms of labour contract by dealing either with local unions or with employees directly, authority to negotiate may be delegated by top management to these subordinates. But where a national union enters into a collective bargaining contract, with the terms of the contract applicable to all workers of a company wherever located, a company cannot afford a high degree of decentralisation.

**Balance—the Key to Decentralisation:** Decentralisation is desirable for many reasons, but extensive decentralisation should be avoided. In addition to the damages from non-uniform policy and the problems of control, there are often real financial costs. As authority is decentralised, managers become more and more independent operators of small business. They may acquire their own accounting force, statisticians, and engineering staff, and these people may soon be duplicating specialised services of the top company organisation.

Perhaps the main problem of decentralisation is loss of control. No enterprise can decentralise to the extent that its existence is threatened and the achievement of its goals is frustrated. If organisation disintegration is to be avoided, selective centralization of certain areas of vital major policy may be done. The company with well-balanced centralisation and decentralisation will probably centralize decisions at the top of such things as financing, overall profit goals, capital expenditures, important new product programmes, major marketing policies, basic personnel policies, and the development and compensation of personnel. The key to effective decentralisation is the proper balance between what is to be centralised and what is to be decentralised.

\*\*\*\*\*

---

## DIRECTION—COMMUNICATION, LEADERSHIP AND MOTIVATION

---

Direction may be defined as the function of management which is related with instructing, guiding and inspiring human factor in the organisation to achieve organisational objectives. The direction is not merely issuing orders and instructions by a superior to his subordinates but it includes the process of guiding and inspiring them.

### Importance of Direction

Direction is an important function of management. Through direction management initiates actions in the organisation, gets things done through orders and provides subordinates' opportunities for developments. It integrates employees' efforts. Their actions are interrelated in such a way that each individual's performance affects the performance of others in the organisation. Moreover, direction facilitates changes, in the organisation. To incorporate and implement these changes, management should motivate individuals affected by these changes.

Direction has the following features:-

- (1) It is an important managerial function.
- (2) It is a pervasive function— it is performed at all levels of management.
- (3) It is a continuous process.
- (4) It starts at the top level in the organisation and follows down to bottom through hierarchy.

### Principles of Direction

Direction is of one of the most complex functions of management as it deals with people whose nature itself is quite complex and unpredictable. Following are the important principles of good and effective direction:

- (1) *Unity of Command*—An employee to receive orders from one boss at a given time.
- (2) *Principle of Managerial Communication*—A superior, through downward communication, passes to his subordinates orders, ideas about work and through upward communication, he knows how his subordinates are working.
- (3) *Principle of Use of Informal Organisation*—Managers should understand, accept and use the informal organisation to supplement and support the formal channels of communication.
- (4) *Effective Leadership*—Dynamic leadership is essential to effective direction. An effective leader guides and counsels his subordinates on work problems as well as on their personal problems.

### Elements of direction.

The process of direction consists of the following functions:

- (a) Supervision,                      (b) Communication,      (c) Leadership,                      (d) Motivation

## Supervision

Supervision refers to guiding, commanding and regulating the efforts of subordinates towards the goals. It involves direct personal contact with subordinates. Supervision is essential for the execution of plans. The supervisor acts as a link between workers and management. Supervision is necessary at all levels of management. It is an important function of every manager.

Quality of a good supervisor: To be effective, must have the following qualities:

1. Technical competence,
2. Managerial skill,
3. Leadership qualities,
4. Initiative.
5. Sense of responsibility,
6. Tact and persuasion.

## Functions of Supervision

A supervisor is generally expected to perform the following functions:

1. To issue orders and instructions and explain management plans.
2. To establish methods and procedures and enforce rule and regulations.
3. To maintain discipline and cooperation.
4. To supply data on current operations to management.
5. To supply tools, materials etc. to workers.
6. To hear workers' complaints, grievances and suggestions.
7. To coordinate and control operations.
8. To recommend pay increases, promotions, transfers etc.

## Communication

Communication is the sum-total of all things one person does to create understanding in the mind of another. It involves interchange of information and thoughts to create mutual understanding. It involves a continuous process of telling, listening and understanding.

This definition reveals the following features:

- (1) Communication involves exchange of facts and thoughts from one person to another.
- (2) It is a two-way process involving sending of a message and receiving the reaction to that message.
- (3) It is a continuous process.
- (4) It is a pervasive function i.e. performed at all levels of management.
- (5) It aims at creating mutual understanding.

## Communication Process

The communication process has the following elements:-

1. **Sender**—The person who intends to make contact with the objective of passing information, ideas to other person is known as sender.
2. **Ideas**—This is the subject matter of communication e.g. opinion, attitude, views, suggestion, order etc.
3. **Encoding**—Involves expressing the message in words and symbols.
4. **Channel**—A communication is transmitted through a channel e.g. radio, telephone etc.
5. **Receiver**—Receiver is the person to whom message is meant for.

6. **Feed-back**—Feed back is the response reaction to the message. It is necessary to ensure that the receiver has received the message and understands it in the same sense as a sender wants.

**Channels of communication**—Communication may be classified as:

- (1) Formal and informal communication, and
- (2) Vertical and horizontal communication.

### **Formal communication**

The formal channel is deliberately created, officially prescribed path for flow of information between the various positions in the organisation. It is designed to ensure that desired information flows smoothly and accurately to the specified points.

The downward and upward communication between a superior and his subordinates are implicit in a formal structure. In order to avoid delays in decision making, organisations now permit lateral or horizontal communication.

Formal communication is systematic and permits an orderly flow of information.

### **Informal Communication**

The informal channel of communication, also known as ‘grapevine’ is the result not of any official action but of operation of social forces at workplace. While formal communication exists to meet the utilisation needs of the organisation, informal communication is the method by which people carry on social, nonprogrammed activities within the formal structure.

Informal communication is faster and more flexible than the formal communication. However, it is erratic and unsystematic. It generally carries rumours and it is not possible to fix responsibility for the distorted information.

It serves as a safety valve for emotions of the employees. It fills a vacuum in formal communication and people often learn managerial decisions long before the formal announcement.

The informal communication is a part and parcel of the organisational process. The only thing management can do is to take suitable action to minimize the adverse effects of this channel. As such, proper analysis of informal communication and a suitable clarification in this aspect will be helpful in making its use towards organisational efficiency.

### **Vertical communication**

Vertical communication refers to the communication between a superior and his subordinates. Vertical communication may be upward or downward.

Upward communication flows from a subordinate to a superior in the form of discussions, suggestions, grievances, reports etc. Downward communication refers to communication from a superior to his subordinates in the form of orders, instructions, rules, clarifications.

### **Horizontal Communication**

Horizontal communication takes place between equals. It helps in creating coordination between different departments and divisions. This type of communication is more relevant to an organisation engaged in research activities.

The more important thing is to find a proper balance between the various types of channels of communication.

## Importance of Communication

The need of good and effective communication arises on account of the following factors:

- (1) **Company Image**—An effective system of communication plays an important role in building harmonious relations with trade unions, consumers, government, etc.
- (2) **Effective Administration**—Through communication, management issues orders and instructions and comes to know of the reactions of subordinates.
- (3) **Coordination**—communication is the most effective means of building coordination.
- (4) **Better Delegation of Authority**—Through communication, subordinates come to understand clearly the limits of their authority and responsibility.

## Barriers to Communication

The following are the important barriers to communication:

- (1) **Badly Expressed Message**—Messages may lack in the coherence, inadequate vocabulary and inappropriate language. The use of semantic words (having more than one meaning) may lead to communication problems.
- (2) **Inattention**—It is a common phenomenon that people simply fail to react to bulletins, notices, minutes and reports.
- (3) **Premature Evaluation**—Premature evaluation is the tendency of prematurely evaluating communications rather than to keep an uncompromised position during the interchange.
- (4) **Resistance to Change**—When the communication involves a change that seriously affects employees, they may not take the message seriously. The basic problem in communication is not of techniques but of proper climate.
- (5) **Mutual trust**—Effective communication is possible when there is lack of confidence and mutual understanding between superior and subordinates.

A good communication atmosphere requires mutual trust and confidence to enable people to appreciate one another's point of view.

- (6) **Fear**—Subordinates may not disclose the facts fully because of the fear of the consequences of such a disclosure. They may deliberately mislead the superior to seek clarification due to the feeling that it will lower down their prestige.
- (7) **Complex Organisational Structure**—An organisational structure involving several layers of supervision, use of staff specialists and a long chain of command is a major barrier to effective communication.

## Principles of effective communication

The following are the principles for effective communication:

- (1) **Principle of Clarity**—Clarity of communication will overcome several barriers to communication. The contents of the message should be clear.
- (2) **Principle of Integrity**—All communications must be formed and transmitted in such a way as to support the integrity of the formal organisation.
- (3) **Principle of Strategic Use of Informal Organisation**—Manager should engage the informal organisation to supplement and strengthen formal channels of communication.
- (4) **Principle of participation**—Both the communicator or sender and the communicator or receiver should take active part in the process of communication.

# LEADERSHIP

## Nature of Leadership

Leadership is the process of influencing the activities of an individual or a group for goal achievement in a given situation. According to Keith Davis, "Leadership is the ability to persuade others to seek defined objectives enthusiastically. It is a human factor which binds a group together and motivates it towards goals." Leadership process consists of three factors—leader, the follower and other variables. The following are the important elements in the process of leading.

- (1) Leader tries to influence the individual in a particular way.
- (2) Leadership makes interpersonal influence possible. It is rooted in feelings.
- (3) It is a dynamic and ever evolving process; a manager must lead continuously.
- (4) It is exercised in a particular situation. The situation variables affect the effectiveness of leadership.

## Leadership and Management

Leadership is sometimes interpreted as synonymous or similar to managership. Management has been defined as the technique of executive leadership. A good leader is not necessarily a good manager but an effective manager must have many of the qualities of a good leader. He is likely to be more effective if he has leadership qualities. A successful manager does not depend only on formal authority. As a leader, a manager must interpret the common objectives to his subordinates and inspire them towards the achievement of these objectives.

## Type of Leadership (Leadership styles)

The problem of leadership style is basically concerned with deciding the extent to which a manager should be dictatorial and the extent to which he is supposed to be participative. Different leadership styles can be categorised as follows:

1. Authoritarian or autocratic style.
2. Democratic or participative style, and,
3. Laissez faire or free rein style. **Autocratic leadership**

This type of leadership is one-man orchestra. He shows the following characteristics:

1. He gives orders which he insists shall be obeyed.
2. He determines policies for the group without consulting them.
3. He gives no information about future plans but simply tells the group what immediate steps they must take.
4. He makes personal praise or criticism to each member on his own initiative.
5. He remains aloof for the greater part of the time.

## Democratic leadership

This type of leader has the following qualities:

1. A democrat gives orders only after consulting the group.
2. He sees to it that policies are worked out in group discussion.
3. He never asks people to do things without giving long term plans on which they are working.
4. He makes it clear that praise or blame is a matter for the group.
5. He participates in the group as a member.



## Laissez faire leadership

Such a leader shows the following qualities:

1. This leader does not lead.
2. He leaves the group entirely to itself.
3. He does not participate.

He may be a man who has been given leadership on grounds of technical knowledge but may be incapable of assuming any control over his subordinates.

## Leadership as a Continuum

There are, in fact, a variety of styles of leadership behavior between two extremes of autocratic and free rein. Tannenbaum and Schmidt have depicted a broad range of styles on a continuum moving from autocratic to free rein.

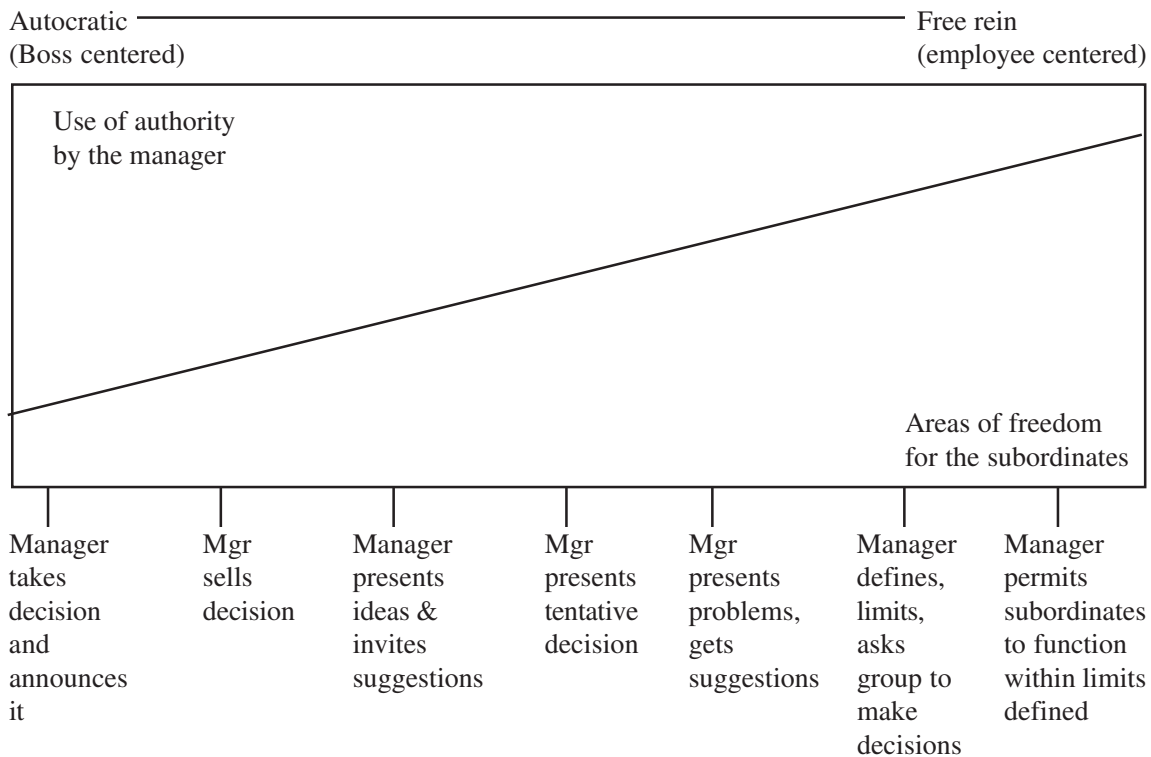

## Functions of Leadership

A leader creates confidence by his superior knowledge and builds enthusiasm by setting an example through his conduct and expression. In the process of initiating important changes and coordinating efforts to manage them, he performs the following functions:

1. *To set goals for subordinates*—A leader gives guidance to the group by setting and interpreting their goals.
2. *To co-ordinate individual and organisational goals*—A leader reconciles individual and common objectives. His main job is to develop voluntary co-operation among employees.
3. *To motivate employees to perform the allotted tasks.*

4. A leader *maintains order and discipline and creates positive* response on the part of members of the group.
5. A leader *represents the group to his superiors and peers* or associates of his status.

### Importance of leadership

A leader guides and directs the members of an organisation towards established goals. He creates and maintains an environment conducive to the effective performance of those individuals for which he is responsible. It is the quality of leadership that generally determines the failure or success of a business enterprise.

*Leadership is the essence of direction* and is provided by a manager who has leadership ability. The leader initiates changes, convinces people about the enterprise goals. No organisation can function effectively without leadership. Leadership is the cohesive or binding force which holds the group intact or as it is, the disciplinary power that keeps the group working towards the goals. He electrifies the current that energises human action, the force that transforms chaos into order, the insight that converts despair or loss of hope into hope and changes half-hearted efforts into superior performance. In fact, there is no substitute for good leadership.

### Theories of leadership

Leadership is a dynamic and ever-evolving concept. Over the years, different concepts about leadership styles have emerged. However, research in this field still continues. Starting with an emphasis on personal abilities and traits of one leader, different approaches about the nature of leadership have evolved. The more important of these approaches are :

(1) **The trait theory**—This theory believes that there are very few persons in society or organisations who are leaders. The vast majority of people constitute of the followers. But what is it that distinguishes leaders. This theory believes in the inborn qualities of an individual.

A number of studies have been conducted to identify traits that can be used to identify successful leaders from unsuccessful leaders. As Ivancevich has also suggested, the most research traits include the following:

- |                                 |  |
|---------------------------------|--|
| 1. Physical characteristics     | — Age, appearance and height   |
| 2. Social back-ground           | — Education, Social status and mobility                              |
| 3. Intelligence                 | — Judgement, knowledge, decisiveness and fluency                     |
| 4. Personality                  | — Alertness, dominance, independence, creativity and self confidence |
| 5. Task related characteristics | — Achievement drive, initiative, persistence                         |
| 6. Social characteristics       | — Attractiveness, popularity, socialibility and interpersonal skills |

Different studies have identified the different number of traits. Though with each study, the list of traits has become longer, some traits are, however, common to all studies. There seems to be a consensus or general opinion that effective leader has intelligence, social maturity, motivation and achievement drive and a human relations attitude.

*Evaluation* (i) Skill are sometimes mistaken for traits.

- (ii) No two lists agree about the essential characteristics and interpretations of different traits also *differ*.
- (iii) The theory fails to pinpoint the intensity and extent to which each of the agreed traits also differ.
- (iv) The theory fails to pinpoint the intensity and extent to which each of the agreed traits should be present in an individual.

2. **The Behavioural Approach**—This approach assumes that leadership is based on what the leader does. The leadership behaviour is the product of the personality of the leader, nature of task, type of group of followers, the goals and the environment. A leader uses technical, conceptual and human skills to exercise influence and modify behaviour of his subordinates.

The term technical skill i.e. ability to plan, organise, delegate, analyse and control refers to a person's knowledge and proficiency in any type of technique. Human skill is the ability to interact effectively with people and to build team work. Conceptual skill deals with ideas and enables a manager to deal successfully with abstractions, to set up models and devise plans. Behaviour of a manager in a particular situation will make him good leader while opposite of this discard him as a leader.

The basic difference between trait approach and behavioural approach is that former emphasizes some particular traits to the leader while latter emphasizes particular behaviour by him. It is true that favourable behaviour provides greater satisfaction to the followers and the person can be recognised as a leader. However, this approach suffers from one weakness, that is, a particular behaviour at a time may be effective while at other times, it may not be effective.

3. **The Situational Approach** : The situational approach does not deny the importance of individual traits in leadership. It goes further and asserts that leadership pattern is the product of situation in a particular group and that leadership will be different in different situations. An individual who is leader in one situation may cease to be so in another situation. Thus, this theory views leadership as a function of the interactions among the managers, the group and the organisational environment.

The situation theory is based on the notion that leaders are made, not born. This approach *focusses* its attention not on the personality of a leader as such, but on the character of the organisation. Anyone can become a leader if circumstances allow him to perform functions dictated by the situation. According to situational theory, an effective leader is one who understands the forces of the situation and works accordingly.

For example, during the historic Railway Strike of 1974 the socialist leader Mr George Fernandes became national hero. This strike was total and spread all over India. After some years when he fought election, he just could not win (in 1980 elections). This example speaks of the contribution of situation theory. When Mr Fernandes was a trade union leader, he was a success. When he came into power, he could not ensure even his election victory.

This theory overemphasises the influence of situational variables. The theory does not point out that the way by which good leaders may be developed. Therefore, the situational approach does not provide a complete explanation of leadership.

## Qualities of a good leader

It is difficult to provide a complete list of leadership qualities. But successful leaders have been found to possess the following types of qualities irrespective of their job and their leadership style—

1. **Sound Physical and Mental Health**—A good leader should have proper physical & mental health.
2. **Empathy**—It refers to the ability to see things from others' point of view.
3. **Self-Confidence**—A successful leader has confidence in his own ability to lead others.
4. **Objectivity**—A leader must be fair and objective in his dealings. Emotional balance, patience, honesty and integrity of character are important virtues of an effective leader.
5. **Decisiveness**—A leader must take initiative, be open minded and should have maturity of his judgement.
6. **Intelligence**—Ability to think clearly and argue precisely is necessary to see the problems in the right perspective.
7. **Responsibility**—A leader needs to have a sense of purpose and responsibility in order to inspire others towards the accomplishment of goals.

# MOTIVATION

## Meaning

Why do people work? Why do some strive for the highest attainments while others are content with mediocrity?

Such questions are central to Management. There are no simple rules for stimulating employees to greater effort. Motivation comes from motives which are expression of human needs by a human-being. All human actions are caused by a particular need or motive. The need can be defined as lack of something. Human beings try to get this lackness removed. Various persons have defined motivation in their own words, like.

“Motivation means a process of stimulating people to action to accomplish desired goals.”

—WILLIAM G. SCOT

“Motivation refers to the way in which urges, desires, aspirations, strivings and needs direct control or explain the behaviour of human beings”.

—D.E. Mc Farland

“Motivation is a general term applied to the entire class of—drives, desires, needs, wishes, and similar forces—when it is said that managers motivate their subordinates. It means that they do those things which they think will satisfy these drives and desires and induce the subordinates to act in a desired manner. On the analysis of these definitions, we can derive the following features:

1. Motivation is a personal and integral or complete feeling,
2. Motivation is a dynamic and continuous process.
3. Motivation causes goal directed behaviour.
4. Motivation is the product of anticipated values from an action and the probability that the action will lead to these values.

The anticipated value is called ‘Valence’. It is defined as the strength of a person’s preference for one outcome in relation to others.

## Process of Motivation

Motives are the ‘whys’ of behaviour. They are the mainspring of action. They are also called as needs, wants or impulses within the Individual. It means something within an individual that prompts that person to take action. Motivation can be viewed as involving a chain reaction—starting out with felt needs, resulting in wants or goals sought for, which give rise to tensions (that is) unfulfilled desires then causing action towards achieving goals, and finally satisfying wants. We can show it as below:—

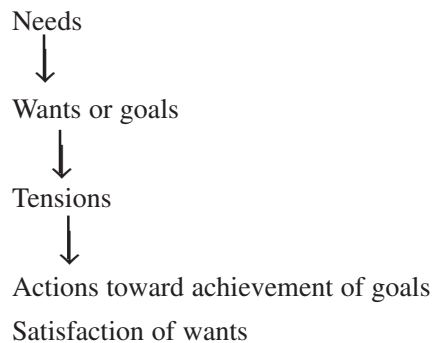

## Importance of Motivation

Motivation is one of the most important factors determining the organisational efficiency. A sound system of motivation is desirable for more than one reasons—

1. Motivation plays an important role in determining the level of performance.
2. High motivation results in low employees' turnover and absenteeism.
3. Effective motivation helps overcome resistance to change and negative attitude on the part of employees.

So, no manager can function if he can't inspire his subordinates to give their best to the organisation.

Every manager is responsible for motivating his immediate subordinates.

## Principles of Motivation

1. **Principle of Participation**—Participation involves consultation with subordinates in matters relating to their jobs. Participation brings loyalty on the part of employees. They feel that they are working for their own organisation.

2. **Principle of Communication**—Communication helps employees understand the complications of motivational system. Motivation to accomplish results tends to increase as people are informed about matters affecting those results.

3. **Principle of Delegated Authority**—Motivation to accomplish results tend to increase as people are given authority to make decisions affecting those results. In this process, people develop sense of belongingness, this leads to more efficiency.

## Techniques of Motivation

Some of the common techniques of motivation used by managers to motivate subordinates are as follows:—

1. **Financial Incentives**—These are a source of satisfaction of both the basic needs and growth needs. These are however, ineffective where basic needs are reasonably satisfied. Pay, bonus, profit sharing etc. are common financial incentives.
2. **Non-Financial Incentives**—Money alone is not sufficient to satisfy the higher order needs.

A man is not motivated by money alone. He can also be encouraged by factors other than money e.g. the job, supervision, status, participation, recognition, etc.

## Sound Motivation System

Since there cannot be a single source of motivation, management should devise a system of motivation within the framework permitted by the enterprise. The following guidelines are useful in developing such a system.

1. A system of motivation should fully integrate human-needs and is consistent with people's motives.
2. A system should be based upon proper selection and orientation of people on the organisation.
3. It should also be productive and motivate people to work more efficiently and according to best of their abilities and skill.
4. A system of motivation should be flexible in the sense that it should be changed in the light of changes in environment.

## Theories of Motivation

The important theories in the field of Motivation are as follows:

1. Maslow's need hierarchy
2. Herzberg's two factor theory
3. McGregor's theory X and theory Y These theories are explained as below

### Maslow's Need hierarchy Theory

A.H. Maslow, an American psychologist, has developed a theory of motivation on the basis of human needs. He has identified the following *five* categories of needs—

- (i) **Physiological Needs:** These needs are essential for survival e.g. Food, clothing, shelter, sleep, sex, rest etc. They are present in all humans and must be satisfied before the individual can consider higher order needs.
- (ii) **Safety Needs:** Safety represent the second level in Maslow's need hierarchy. They relate to physical and economic security. Physical security in terms of safety against fire, accident etc. Economic security relates to unemployment, old age, sickness etc.
- (iii) **Social Needs:** Next in order comes the social needs. When psychological and safety needs are fairly satisfied, social needs become powerful motivators. These needs are what Maslow calls "*the love and affection and belongingness need*".
- (iv) **Ego or esteem Needs:** They imply needs for recognition, self confidence and achievement, status, prestige and attention. Ego needs become powerful motivators only when all the three lower order needs are reasonably satisfied.
- (v) **Self Actualisation Needs:** These are related to personal growth and realization of man's full potential. As Maslow puts it—

*What a man can be, he should be. A teacher must teach, a singer must sing, a housewife must cook.* The above stated needs can be shown with the help of the following figures—

Management should bear in mind that in all circumstances satisfied needs are no more powerful motivator of human behaviour. Maslow has demonstrated this picturing the average citizen as 85 per cent satisfied in his physiological needs, 70 per cent in his safety needs, 50 per cent in his social needs, 40 per cent in his ego needs, 10 per cent in his self actualisation needs.

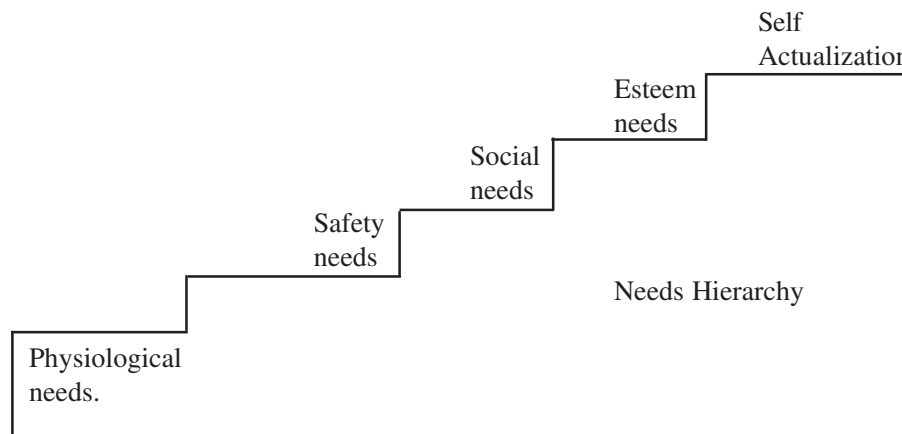

Lower to Higher Level  
Figure: Maslow's Need Hierarchy

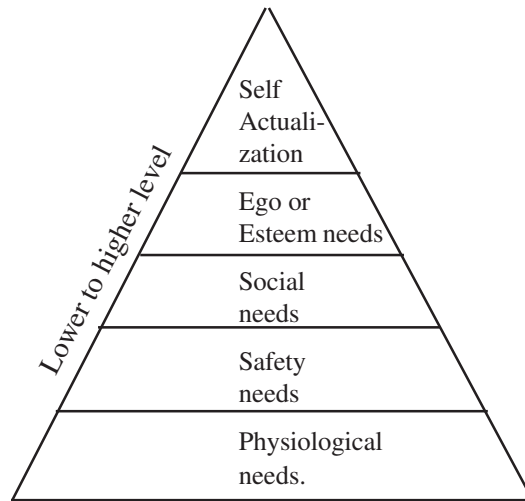

Strength of Needs  
Figure: Maslow's Need Hierarchy

2. **Herzberg's Two Factor Theory**—This two factor theory of Motivation, based on what are called hygiene factors, was developed by Frederick Herzberg of U.S.A. He derived his conclusions from a research study conducted on a group of 200 engineers and accountants. Those interviewed were asked to describe when they felt good about their job and when they had bad feelings about (it their job).

'The motivational factors' lead to high job satisfaction and strong motivation. These are related to job content e.g. advancement, recognition, challenging work, increased responsibility, and opportunity for growth.

The 'Hygiene' factors are necessary to avoid dissatisfaction. Their presence may not motivate workers but absence will certainly demonstrate them. These factors are also known as 'maintenance factors', e.g. company policy and administration, supervision, interpersonal relations, working conditions, salary, job security.

### Comparison of Herzberg and Maslow Models

When Herzberg and Maslow models are compared, both these models focus their attention on what motivates.

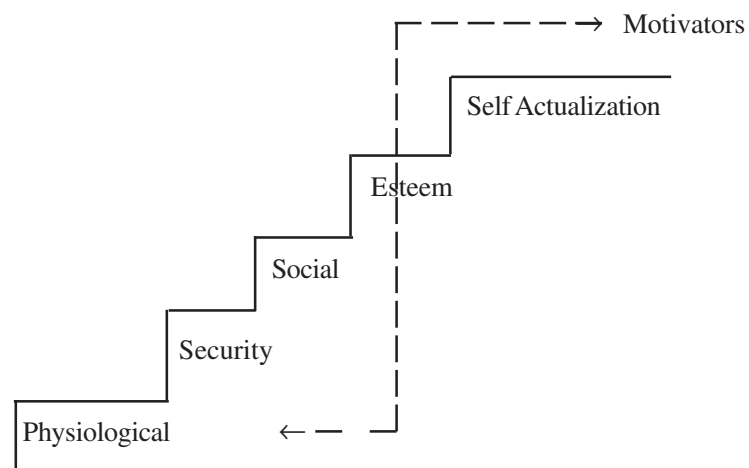



It is clear from this figure that the physiological, safety, social and part of the esteem needs are all hygiene factors. The esteem needs are divided because there is a difference between status and recognition. Status tends to be a function of the position one occupies. One may have gained this position through family ties or social pressure. Recognition is gained through competence and achievement. So, status is classified with psychological needs while recognition is classified with esteem as a motivator.

## **McGregor's Theory X and Theory Y**

McGregor has identified two sets of assumptions regarding human behaviour under the titles theory 'X' and theory 'Y'. McGregor suggested that managing must start with the basic question of how managers see themselves in relation to others. This view point requires some thought on the perception of human nature. Theory X & theory Y are two sets of assumptions about the nature of people.

### **'Theory X'**

This theory makes the following assumptions:—

1. An average person lacks ambition, responsibility and prefers to be led.
2. An average human being is passive.
3. A person is self centered.
4. He is resistant to change and wants security above other things.
5. A worker is mostly motivated by physiological needs.
6. Because of these characteristics, most people must be controlled, directed and threatened with punishment in order to get them to put forth adequate efforts towards the achievement of organisational objectives.

### **'Theory Y'**

The democratic set up of society, more educational standards and training on the part of employees have called for a better approach i.e. theory 'Y'. It is based on the following assumptions.:—

1. Work is as natural as play. A worker has no inherent dislike for work.
2. He takes initiative. He is ready to take responsibility.
3. He is generally motivated by higher level needs of Maslow's theory.
4. The capacity to exercise a relatively high degree of imagination and creativity in the solution of organisational problems is widely distributed in the population.
5. The degree of commitment to objectives is in proportion to the size of the rewards associated with their achievement.
6. External control and the threat of punishment are not only means for getting work done. People will exercise self direction and self-control in order to attain organisational objectives.

These two sets of assumptions are fundamentally different. Theory X is pessimistic, static and rigid control is external, that is, imposed on the subordinate by the superior. In contrast, Theory Y is optimistic, dynamic and flexible, with an emphasis on self-direction and the integration of individual needs with organisational demands. Each set of assumptions will affect the way managers carry out their managerial functions and activities.

McGregor was of the opinion that theory X & theory Y might be misinterpreted. There are some points which clarify the areas of misunderstanding. First point is theory X and theory Y are assumptions only. They are not prescriptions or suggestions for managerial strategies. These assumptions must be tested against reality. These assumptions are not based on research. They are mere deductions. Second point is that theories X and Y do

not imply “hard” or “soft” management. The hard approach may create resistance and authoritarian approach. The soft approach may result in laissez-faire management and is not consistent with theory Y. Instead, effective manager should recognise the dignity and capabilities, as well as the limitations of people and adjust behaviour as needed by the situation. Third point is that theories X and Y are not to be viewed as being on a continuous scale, with X and Y on opposite extremes. They are to be viewed as completely different views of people. Fourth area to be clarified is that theory Y does not mean an argument against the use of authority. Instead, under theory Y, authority is seen as only one of the many ways, a manager exercises leadership. Fifth point is that different tasks and situations require different approaches to management. Thus, the productive enterprise is one that fits requirements to the people and the particular situation.

## Morale

Morale implies a person’s attitude towards his job, organisation and the superiors. Morale is best understood as one’s attitude towards accomplishing his work rather than emotions he displays during work. Morale is basically a group phenomenon. It is a concept that describes the level of favourable or unfavourable attitudes of the employees collectively to all aspects of their work—the job, the company, their tasks, working conditions, fellow workers and superior. Attitudes express what the individuals think and feel about their jobs. The emphasis is on how employees feel, denoting the strong emotional elements associated with attitudes.

## Morale and Productivity

It is generally believed that there is a high correlation between morale and productivity. Research has not proved the assumption that higher the morale, higher the productivity and vice-versa, e.g. an increase of five per cent in morale does not lead to proportional increase in productivity. The two may be related in four different ways as stated below:

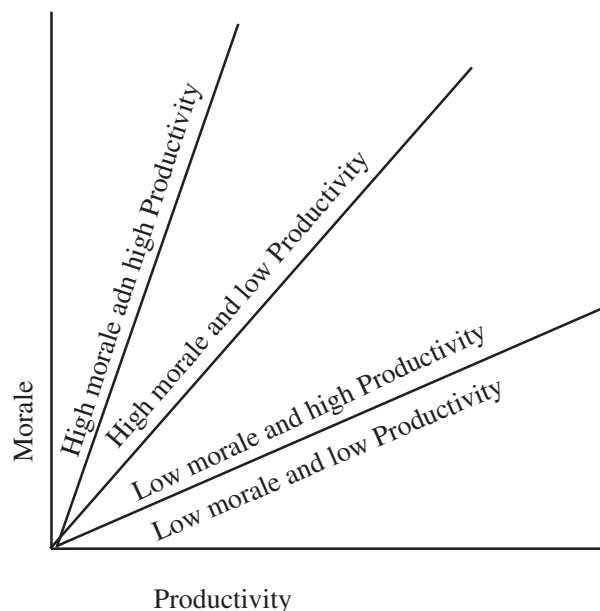

- (i) **High Morale and High Productivity**—High morale leads to high productivity when the employees are motivated. It leads to optimum utilisation of human resources.
- (ii) **High Morale and Low Productivity:**—A negative relationship between morale and productivity arises when employees do not feel committed to the goals.

- (iii) ***Low Morale and High Productivity:***—Such a relationship may exist when management uses the best technology and penalties for low productivity.
- (iv) ***Low Morale and Low Productivity:***—Low morale means lack of job satisfaction, unwillingness to work.

Thus there is no clear and definite relationship between morale and productivity.

\*\*\*\*\*

## LESSON 2

---

# CONTROL : CONCEPT AND PROCESS

---

Controlling involves measuring and correcting the actions of subordinates to assure that events conform to plans. Thus it measures performance against goals and plans, shows where negative deviations exist, and, by putting in remedial action to correct deviations, helps assure accomplishment of plans. The basic control process involves three steps: (1) establishing standards, (2) measuring performance against these standards, and (3) correcting deviations from standards and plans. Let us discuss these steps one by one:

(1) **Establishment of Standards:** Because plans are the yardsticks against which controls must be devised, it follows logically that the first step in the control process would be to establish plans. However, since plans vary in detail and complexity and since managers cannot usually watch everything, special standards are established. Standards are by definition simply criteria of performance. These standards may be stated in physical terms, such as qualities of products, units of service, man hours, or speed, or they may be expressed in monetary terms, such as volume of sales, cost, capital expenditure, or profit. They may also be expressed in qualitative terms or in any other way that can give a clear indication of performance. No matter how these standards are expressed, these are the selected points against which actual performance is compared so as to give managers signals as to how things are going without their having to watch every step in the execution of plans.

(2) **Measurement of performance:** The second step in the control process is the measurement of the performance of the subordinates. The measurement of performance may be quite simple if it is to be compared against man-hour standards for the production of a mass production item. But it may be very difficult task if the item is made according to the likes and dislikes of individual customers. Similarly, appraisal of performance may be very difficult in the less technical kinds of work. Thus, we can say that appraisal depends upon standards—if they are definite, performance will be easy to measure; if they are vague, performance will be difficult to measure.

(3) **Correction of deviations:** This is the third step in the control process. Correction of deviations clearly brings out the relation between control and other functions of management. Managers may correct deviations by redrawing their plans or by modifying their goals. Or they may correct deviations by exercising their organising function through reassignment or classification of duties. They may correct it by additional staffing, by better selection and training of subordinates. Or again, they may correct it through better or fuller explanation of the job or by more effective leadership techniques.

### Requirements For Adequate Controls

All alert managers want to have an adequate and effective system of controls to assist them in making sure that events conform to plans. The following requirements should be kept in mind for designing an effective control system:

(1) **Control should Reflect Plans and Positions:** All control techniques and systems should reflect the plans these are designed to follow. Every plan has unique features. Managers require information on how well the various plans are working. The information required to evaluate the progress of different plans varies from one plan to another. The controls should be so designed that they provide different types of information for evaluating different plans.

In the same way, control should be tailored to positions. Different controls are required for different persons incharge of different departments. What may be suitable for one incharge may not be suitable for another incharge.

Therefore, effective controls are those which best serve the specific requirements of different heads of departments or sub-departments.

(2) **Controls must be Tailored to Individual Managers and their Personalities:** Controls must be tailored to the personalities of individual managers. If they are not of a type that a manager can or will understand, they will not be useful. Some people, such as statisticians and accountants, like their information in forms of complex tables of data or bulky computer print-outs. In such cases, let them have it that way. The important thing is that various controls should provide the managers with the information they need in a manner that they will understand and use.

(3) **Control should Point out Exceptions at Critical Points:** Controls should point out exceptions so that managers may concentrate on them for remedial measures. They should also indicate which deviations are more important and which are less. A manager, for example, might be concerned if the cost of labour deviated from budget by 5 per cent, but he is unworried if the cost of postage stamps deviated from budget by 20 per cent. Therefore, controls should point out exceptions only at critical points. It is true that more the managers concentrate their control efforts on exceptions, the more efficient their control mechanism will be. But this principle is best understood in the light of the fact that effective control requires managers to pay primary attention to those things which are most important.

(4) **Controls should be Objective:** Effective control requires objective standards. Whether a subordinate is doing a good job should ideally not be a matter of subjective determination because in that case judgements of performance will be inaccurate. But if the standards are objective and measurements are kept upto-date through periodic review, controls would be more effective.

(5) **Controls Should be Flexible:** Controls should remain workable in the face of changed plans, unforeseen circumstances, or outright failures. If controls are to remain effective, despite failure or unexpected change of plans, they must be flexible. The need for flexible control can readily be illustrated. A budget system may project a certain level of expenses and grant authority to managers to hire labour and purchase materials and services at this level. If this budget is based on a forecast of a certain level of sales, it may become meaningless as a system of control if the actual sales volume is considerably above or below the forecast. The inflexibility of such a budget would disqualify it from being an effective control technique. What is needed, therefore, is a budget that will reflect sales variations as well as other deviations from plans. This requirement is provided by the flexible budget.

(6) **Controls should be Economical:** Controls must be worth their cost. Although this requirement is simple, it is often difficult to accomplish in practice. It is difficult to undertake a cost-benefit analysis of a control system. However, controls should ideally bring to light the causes of actual or potential deviations from plans with the minimum of costs.

(7) **Controls should Lead to Corrective Action:** An adequate system will disclose where failures are occurring and who is responsible for them, and it will ensure that some corrective action is taken. Control is justified only if deviation from plans are corrected through appropriate planning, organizing, staffing and leading.

(8) **Controls should be forward-looking:** There is usually a time lag between the measurement of performance and correction of deviations. This time lag is undesirable. What managers really need for effective control is a system of control that will tell them in advance that problems will occur if they do not do something about now. Effective controls are those which are directed towards the future.

## **Significance of Control**

Controlling is a basic function of management. It ensures that actions proceed according to plans. A well-designed system of control permits top management to delegate authority, free itself of unnecessary detail, and ensure achievement of plans. Management control serves as a yardstick for allocating resources and evaluating performance. It provides a guide to future action. It provides order and discipline in the organisation. Realistic

control simplifies supervision by pointing out only significant deviations. Realistic control helps the management in achieving the enterprise objectives in the most efficient manner.

## **Techniques of Managerial Control**

A variety of tools and techniques have been used to help managerial control. Some of these techniques may be classified as traditional in the sense that they have been used for long by the managers. Some of the traditional techniques of control are: budget, statistical data, special reports and analyses, operational audit and personal observation. Other techniques like Programme Evaluation and Review Technique (PERT) etc. represent newer generation of planning and control tools.

### **Traditional Techniques**

**A. Budgetary Control:** A widely used device for managerial control is the budget. A budget is a plan showing how resources will be acquired and used over a specified time interval. The act of preparing budgets is called budgeting, and the use of budgets as a means for controlling activity is called budgetary control.

**Benefits of Budgetary Control:** Budgetary control leads to maximum utilization of resources with a view to ensure maximum returns because it provides aid to managerial planning and control. Following are some specific advantages of budgetary control.

1. Budgets are the result of planning function and as such they direct every action of the organisation towards goal achievements. Budgets also provide a basis for coordination and integration of various activities in the organisation.
2. Budgetary control involves measuring performance and comparing it against budgeted figures. Through this process, the variations are struck out and responsibilities fixed. In this light, reports are prepared and presented to management and suitable actions are taken. Thus, budgetary control is used as an effective and integrated control tool.
3. Budgetary control makes people in the organisation conscious about cost and performance. This leads to effective utilisation of organisational resources such as labour, machines, and materials.
4. It is somewhat a democratic way of managing and control. In the organisation where budgetary control is exercised, generally more authority for preparing budgets is delegated to subordinates. Thus, there is no undue centralisation of authority. The delegation of authority is a condition precedent to the success of budgetary programme. Moreover, there is a participation in management at all levels of the organisation in the preparation of budgets.

### **B. Non-Budgetary Control**

1. **Statistical Data:** Statistical analysis of the innumerable aspects of business operation is important to control. Analysis in terms of averages, percentages, ratios, correlation, etc. provides help for control. Such areas of control are production, planning and control, quality control, inventory control etc. Various tools indicate the deviations from the standard and suitable managerial actions in respect of these.

2. **Special Report and Analysis:** For control purposes reports and analysis help only in some particular problem areas. While routine accounting and statistical reports provide necessary information for control in general, there may be some areas where these may fall short of requirements, particularly in the case of specific problems of contingency. For this purpose, an investigating group may be assigned the job to go into details of the problem and to prepare a report for this purpose. The problem in this case is generally of non-routine type.

3. **Internal Audit:** Internal audit, now largely called operational audit is an effective tool of managerial control. Internal audit is carried out by managers themselves or by special staff appointed for this purpose. In contrast to external audit which remains unconcerned with the operational aspects of the organisation, internal audit is much broader in scope and encompasses the whole range of activities of the organisation. Thus internal

audit, in addition to ensuring that accounts properly reflect the facts, also appraises policies, procedures, use of authority, quality of management, effectiveness of methods, special problems, and other phases of operations; the latter aspects being more emphasised in present day internal audit. However, there are certain problems in broadening the scope of internal audit in these areas because of the limited ability of an organisation.

Internal audit provides managers with a perennial or everlasting supply of control information. By measuring performance and evaluating results in the light of the standard, internal audit makes suitable recommendations for managerial actions. It also scrutinizes the applicability and relevance of policy, procedure, and method which have a tendency to become obsolete. Such a scrutiny helps in choosing a suitable working procedure and methods. The introduction of internal audit tones up morale fibres and working efforts of all members in the organisation as it involves the risk of being exposed before the management and people try to avoid errors of omission and commission.

The internal audit is not free from its limitations. Its installation and operation require extra costs which may be too much for smaller organisations. Sometimes, the reports of internal audit team may not be acceptable to the manager because of some deficiency. The audit people have a tendency to look at every aspect of business operations from accounting point of view. This not only affects the scope of internal audit, but also leads to faulty conclusions. However, in recent years, the system of internal audit has been raised to new heights by organising a centralized audit unit for the purpose of supplying greater and wider control information to managers. In managing such a unit, accounting qualification alone are not adequate, but the greater emphasis is being given to managerial skill and experience. To avoid accounting bias, internal auditors in many organisations are selected from the rank of line managers.

4. **Personal Observation:** Though various devices of managerial control such as budgets, standard cost, statistical tools, audit reports and recommendations are quite helpful in managerial control, managers should not forget the importance of control through personal observation. Managers need to hold discussion with the persons whose work is being controlled and they should visit the actual operations. There are certain kinds of impressions and information that can be conveyed only through face-to-face contact, personal observation and conversation. When a man is new to the job, a supervisor will like to watch his work more closely than that of an experienced operator. Managers, after all, have responsibility of achieving organisational objectives, whatever control devices they may use. This largely involves measuring of human performance. Thus, the success of personal observation as a control method depends upon how much information a manager can collect through this process.

5. **Break-even analysis:** It is mainly concerned with the effect which changes in fixed costs, changes in variable costs, changes in sales volume, changes in the sales prices and changes in sales mix will have on profits. Therefore, it establishes a relationship between cost of production, sales at which total cost is fully covered and beyond which profits will be earned and below which there will be a loss. The volume of sales at which sales revenue exactly equals total cost or there is no profit or loss is known as 'break-even point' This break-even analysis can be shown graphically also, (shown below)

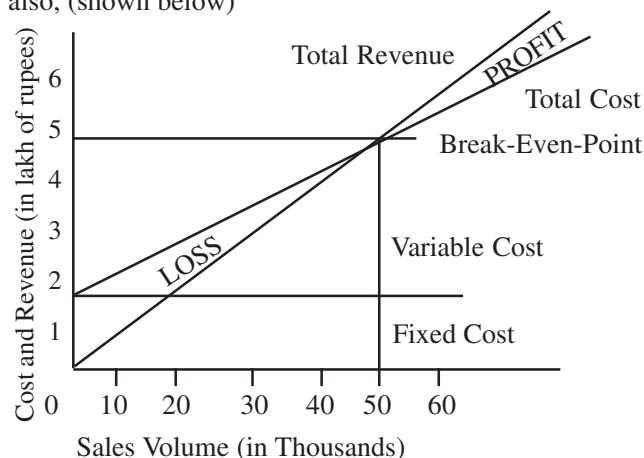



In the above graph, suppose fixed cost is Rs. 1,5 lakhs and variable costs and sales price are Rs. 7 and Rs. 10 per unit respectively. Here break even point is 50,000 units of sales because at this point the total cost is equal to the total revenue. At this point the total cost is Rs. 5 lakhs represented by fixed cost of Rs. 1.5 lakh and variable cost—Rs. 3.5 lakhs and the total revenue is also Rs. 5 lakhs (i.e.,  $50,000 \times 10$ ). The spread to the right of this point represents the profit potential and the spread to the left shows the loss potential.

Break even analysis presents information regarding total cost, revenues, profit/loss at various levels of production in such a manner that it is easily understandable. It is based on the division of total costs into fixed and variable. Some examples of fixed cost are represented by depreciation, insurance charges, property taxes, cost of maintaining office, etc. Variable costs may include direct material costs, labour costs and commission rates on sales. The management can't have control over the fixed costs, but it can exercise control over the variable costs. The assumption of this analysis is that it is possible to identify fixed and variable components of cost but this is not very true in actual practice. Moreover, fixed costs remain fixed only upto a certain level of production after which they will rise considerably. Another difficulty with this analysis is that the break-even point is not fixed. It changes with every management decision that is when selling price changes, while operating efficiency changes, when product-mix changes and so on.

## **2. Modern Control or Network Techniques**

Network analysis is a means of planning and controlling the project activities. Under this, a project is broken down to small activities or operations which are arranged in a logical sequence. After this, the order in which the various operations should be performed is decided. A network diagram may be drawn to show the relationship between all the operations involved. So it will reveal the gaps in the flow plan.

The net work drawn thus shows the interdependence of various activities of a project and also points out the activities to be completed before the others are started.

The object of network analysis is to help in planning, organizing and controlling the operations to enable the management in accomplishing the project economically and efficiently. The most popular network techniques are:

### **A. PERT (Programme Evaluation and Review Technique)**

It is an important technique in the field of project management. It involves planning, monitoring and controlling of projects. It specifies the techniques and procedures to assist project managers in:

1. Planning schedules and costs.
2. Determining time and cost status.
3. Forecasting man power skill requirements.
4. Predicting schedule slippages and cost plans.
5. Developing alternate time cost plans.
6. Allocating resources among tasks.

PERT uses probability and linear programming for planning and controlling the activities. Probability helps in estimating the timings of various activities in the project and linear programming is used to maximize the achievement of the project objectives. PERT is employed in the construction of ships, buildings and highways, in the planning and launching of new projects, in the publication of books, in the installation of computer system, etc.

## **B. C.P.M. (Critical Path Method)**

It is most widely used as a planning and control technique in business. Unlike PERT, it is applied in those projects where timing are relatively well known. It is used for planning and controlling the most logical sequences of activities for accomplishing a project.

Under CPM, the project is analysed into different operations or activities and their relationships are determined and shown on the network diagram. The network is then used for optimizing the use of resources and time. CPM marks critical activities in a project and concentrates on them. Here assumption is that expected time is actually the time taken to complete the project. CPM requires a greater planning than required otherwise. Thus, it increases the planning cost, but this increase in cost is justified by concentrating on critical path only and avoiding expenses on the strict supervision and control of the whole project. Besides ascertaining time schedule, CPM provides a standard method of communicating project plans, schedules and costs.

\*\*\*\*\*

---

## MARKETING MANAGEMENT—NATURE, IMPORTANCE AND CONCEPT

---

According to American Marketing Association, “marketing is the performance of Business activities that direct the flow of goods and services from producer to consumer/user”. Hence, Marketing is the managerial process by which products are matched with markets and through which transfers of ownership are effected.

Institute of Marketing of U.K. has defined Marketing as “the creative management function which promotes trade and employment by assessing consumer needs and initiating research development to meet them. It co-ordinates the resources of production and distribution of goods and services, determines and directs the nature and scale of the total efforts required to sell profitably, the maximum production to the ultimate user”. Sometimes, selling and marketing are considered as same things. But selling is normally considered with the plans and ideas of trying to make consumer exchange what he has (money) for what we have as producers (goods or services). Whereas, Marketing is related to the needs of the buyer and is limited to the ideas of satisfying a consumer’s requirements by means of the products as well as by giving the customer with value satisfaction which ultimately ensures the profitability of activities of the concern. Hence, Marketing thinking must precede the production activities. Even when the product reaches the customer, it must satisfy the customer with after-sales service also.

Hence, we can also define the Marketing Management as “the process of ascertaining consumer needs, converting them into products or services and then moving the products or services to the final consumer/user to satisfy such needs and wants of specific customers segments with emphasis on profitability while ensuring the optimum use of the resources available to the organisation”. This definition includes these 3 important features

- (a) consumer study/orientation,
- (b) profitability for the concern and
- (c) the Optimum use of available limited resources.

***Relationship of Market with Product:*** There is a direct correlation between the marketing on the one side and the product on the other. Marketing is the business, whereby specific products are matched up with specific markets and think of production as the business process is related with the manufacture of these products. The top management of the company has the final responsibility of selecting, manufacturing and marketing the products that possess maximum features desired by the customers at large for the ultimate satisfaction. Products are matched with markets, firstly, through market research which give the manager an idea about the demand of the product and secondly, through the top management, in co-ordination with production in its favour by adopting personal selling, advertising, distribution and price policies which are regularly modified with the change in the market. Hence, we can certainly say that modern management regards marketing and production as interdependent sub-systems.

***Marketing management & Sales management:*** Marketing & sales management are quite separate items though related to each other. Sales Management can be defined as “the planning, direction and control of the personal selling activities of a business unit including recruitment, training, assigning, supervising, paying and motivating such personal sales force.”

In India, these are synonymous terms but there is a difference between a Marketing manager and a Sales Manager, as the sales manager's function is limited to planning, directing and controlling the activities of salesmen. Marketing Manager is holding a line status over and above the sales manager as the former has to supervise the work of the sales managers.

**Meaning & functions/tasks of the Marketing System:** The following are the interrelated tasks of the Marketing System—

- (a) all the business organisations perform the marketing function.
- (b) the legal, historical and customary relationship exist among these organisations wherein every business-unit is both a buyer and a seller.
- (c) the customer service and
- (d) the marketing functions are performed by a marketing system in each of these organisations.

(A) **Business Institutions and their relations:** The producers of raw-materials and their concerns like farms, mines and fisheries, manufacturers and processors of finished and semi-finished goods, service industries like Banks and insurance companies, intermediaries like retailers and wholesalers deal with customers—domestic, industrial and the Government etc. These organisations normally perform their functions through specialisation and the domestic consumers satisfy their needs with the ultimate product whereas the business customers use the product to produce other goods and services.

(B) **Marketing environment:** The internal and external factors affect the marketing system. Some factors are controllable while others are not and the marketing management has to take care of these controllable and uncontrollable/environmental factors. External factors are of 3 types-competitors, legal & political and Science & technological factors. The Competitors' factor is always taken care of so that it may not give any adverse effect to the company. It is also the management's concern to evaluate and counteract the marketing moves of the competitors. Management is also concerned with legal and political climate to make the marketing decisions. Public opinion should be considered for the proposed marketing changes. The present condition of science and technology try to limit the range of possible marketing moves. Other environmental/ external factors are like psychological, cultural, sociological and economic which ultimately control the management decisions indirectly on buying behaviour. Psychological factors, personal to an individual, include needs for self-honour which will influence the human behaviour. Cultural factors help to explain why Indians preferred Dhoti to full pants, sociological factors like a friend using a Car will force his friend to buy a car. Economic factors like present and the future income decide to buy a thing today or tomorrow.

(C) **The customers and the Business Institutions:** Consumer and industrial goods markets need separate thinking and planning because ultimate consumers buy for his own or family use. While the industrial buyers purchase for the furtherance and the production of other goods and services. They are known as industrial products. Some business enterprises make profits whereas others are non-profit institutions like Schools, hospitals and Government agencies. Their expenses are audited by outside authorities and hence require systematic purchases. Hence, the difference between the two is that the first uses his part-time to make purchases whereas the industrial users employ paid professionals to devote full time for making purchases.

(D) **Task of the marketing system:** The marketing system performs the task of adjusting the production of goods and services to requirements of the customers. The final end of production is consumption. Therefore, the main job of marketing system is to orient the production in such a way as to satisfy the demand of the product/service. The marketing system must give due consideration to the risk of physical deterioration or damage in the value of the product. Further the marketing system must show to the wholesalers and retailers about the available stock of the products, their prices and the conditions of sales through the help of catalogues, trade display and through personal salesmanship so that customers should be well informed about the product.

***Marketing Management tasks and philosophies*** : Market is a system or an atmosphere or mechanism that facilitates such forces as are leading to price fixation. That is, physical presence of goods or men at a place is not an essential condition of a highly developed and elastic market. It provides an atmosphere where both buyers and sellers are in touch with all the communication that brings into play the “price fixing agents”. On the contrary, marketing is the sum-total of all these activities that are related to the free flow of goods from the points of production of goods and this is the hall-mark of marketing, that is, once the price fixation is done, the journey starts from sellers to the buyers. In a nutshell, ‘market’ is a solid foundation to push the sale of goods. It is an outlet to let out the produces. It is the key to the engine or marketing. On the other hand ‘marketing’ is a gigantic machinery to move the goods by creating utilities of place, time and ownership. It is a tree with a number of tentacles and ramifications to actually provide shade to the customers, or providing them the required goods and services to their satisfaction.

***Significance of Marketing***: Any economy, developed or under-developed or developing, whether pure or cock-tailed, is a market oriented economy. Industry, today, involves the production of all the essential goods for a profitable sale rather than for self or borne consumption by the producer and his immediate households. Since, ‘profit maximization’ is the watchword of any prudent producer and discerning distributor, this marketing system, constitutes the bed-rock foundation for the production. That is, production and marketing are the two pillars of an efficient economy, where as, production and consumption are the two wheels of an economy which are linked by the powerful belt of marketing. By its very nature, a market oriented economy is a dynamic economy, characterized by the steady growth and expansion of markets. In such an economic system, it is the function of marketing system to transform the benefits of productive efficiency in terms of higher levels of living via distribution. If the levels of living are low in any country then that can be directly attributed to the least developed marketing system. The need for the market grows out of the division of labour, mass and specialized production calls for the existence of mass markets in which the entire output can be put in or pushed out at a reasonable margin of profit. To reach the far-flung markets of the world, marketing services are inevitable.

***Society and Marketing*** : It is an instrument to lift up the living standards even though human life is a patent example of interdependence, different sections of society are habituated to different standards of living. Differences in the manner of living are caused by such things as family and class traditions, educational and cultural influences, and social pressures of membership of different groups. There is a small class of people that enjoys highest standard of living. It is that class where people have dozens of shirts, suits, pants, shoes, ties, fleet of cars, batch of scooters; still they are not very happy. On the contrary, there is another class namely, poor class where it forms a vast majority with subsistence level or hand to mouth level of living. They are worse off, as they neither get sufficient staple food, reasonable shelter, and shattered shirts and patched pants, nor any scope to come up; still they are happy with whatever they get, as minds are rich in their case. In between these two extreme classes of rich and poor, there is still another group popularly known as middle class. In fact, it is considered as the backbone of the nation. Unfortunately, this middle class is neither fully happy nor unhappy i.e. above the ordinary class and below the top class, leading a middle standard of living. Despite all such differences in their levels of living, every member of the society requires certain commodities and services to enjoy, to make his living decent and gracious. Therefore, for everything and anything, every body is to depend completely on this gigantic system. Thus, the shirts and pants you wear, bananas and underwears that you use, the hair-oils and tooth-paste that you apply, the face powder and snow that you use in make up, the medicine you consume, the cycle you ride on, the cars and scooters that you drive, the food you eat, the drinks cold or hot you take all are made available by marketing. Marketing of course, is not the sole economic determinant of the standard of living. It is, however, one of the triumvirate of important economic determinants of production, purchasing power. Marketing is a means through which production and purchasing power are converted into consumption.

Just as every industry provides employment opportunities to thousands of skilled and unskilled labour in various capacities, marketing does provide millions of employment opportunities which are gainfull. As you are aware, marketing is a complex mechanism involving number of functions and sub-functions which call for different specialized persons for employment. The major marketing functions are, buying and selling, transport,

warehousing, financing risk-bearing, market information and standardization. In each such function, different activities are to be performed by a large number of individuals or institutions. It is said that, roughly about 30 to 40 per cent of the total population is dependent on marketing directly or indirectly. They use this as a means of livelihood. This is of special significance to our country, where there are 'population explosions and unemployment problems' that are acute and terrifically awful. Economic stability is the sure sign of any efficient and dynamic economy. It implies that economic activities are not only at high level of performance but they are regular and continuous. It refers to the economic soundness of the nation which is consistent.

In other words, it implies existence of full employment, stabilized and flexible prices, perfect match of production with consumption. However, at times, due to certain drawbacks of natural and artificial factors, this economic stability may be disturbed. Due to extreme specialization and application of the principle of division of labour, production and distribution have become two separate sections of the economic organisation. Today, production is one thing and distribution another. Both are inter-dependent but not independents of one another. That is why, if the balance is lost, that creates intolerable and uncontrollable situation. If one of the wheels is out of order, it becomes a net-work for continuous trouble. That is, if production is more than what is required or vice-versa, economic life is ought to be perturbed. Now let us see how this excess production and lack of sufficient production affect the economy and economic stability. Profit is the core on which the whole super-structure of business is built. Profit is the pivot around which all marketing activities rotate. To earn this cream of profit, businessmen have to struggle hard, as there is no magic formula to have "wind fall profits". There must be some instrument through which profits can be earned and multiplied. Marketing does provide many opportunities to earn profits in the process of buying and selling the goods, by creating time, place and possession utilities. Moreover for earning and realization of profits by producers and distributors implies an improvement or refinement in the fields of production and marketing, Which can be possible only from research programmes.

The problems of an entrepreneur are what, how, when, how much and for whom to produce? In the dead past, producer was in direct contact with consumers; since the needs of the community were very few and simple, they could be met very easily or even locally.

Thus, there were no intermediaries between producers and consumers. However, with the flight of time and as society developed economically, socially, politically, ethically, and culturally, the needs of refined people sprang into manifold varieties. To meet out this challenge, division of labour was applied. Production became mass and round-about. As the direct link was cut off, great gulf was created between producers and consumers. This was the opportune time when the middlemen entered the scene. Thus, marketing emerged as a new specialised activity along with production. As a result, producers are depending largely on the mechanism of marketing to decide what to produce and sell. Each producer is to feel the pulse of market via 'marketing stethoscope' to make out as to what is going-on in the market.

The trends in the market are always changing because, markets are ever growing and, therefore, dynamic. Such changes have far reaching effects on production and distribution. Today the minds of the buyers are not firm, but fluctuating very often. That is why, it is said "mood of the market changes fast like the taste of a fickle minded mistress". Meaning thereby, the fashions, habits, tastes, and dislikes, preferences, styles do change with time, place and person. The producers will succeed, when they meet the new requirements or new demand of these ultra-modern people. Marketing as an instrument of measurement, gives scope in understanding this new demand pattern and thereby produce and make available the goods accordingly.

**Cost of Marketing :** In recent years, marketing is blamed because of its high cost. Nowadays, it has attracted the attention of different sections of the society, who have taken keen interest in the analytical study of marketing costs. Marketing costs are stated to be high. It is almost impossible to estimate accurately, the overall cost of marketing function and services; however, many marketing experts have tried to calculate and have found that marketing costs accounts to about 50 per cent of the price paid by the consumers. The study of "Marketing of Wheat, Rice and Cotton in India" indicated that 50 to 60 per cent of the total cost accounted for is for the marketing costs. It means that, out of a rupee paid by the consumers, 50 paise go to the marketing men.



The reasons are many to support this argument of high cost. Only significant are noted here. At present, we, the refined people of ultra-modern world, believe in specialization and roundabout production. Of course, large-scale production of today has been instrumental in bringing down the cost of production, improving the quality and multiplying the varieties. Thus, efficacy of production field has ever been on the line of improvement. However mass-production has been concentrated at few places all over the world. It is this concentration of production that has become a root-cause for the increase in costs of marketing. There is a big gap between the points of production and consumption. This gap is bridged or engulfed by an army of middlemen both as merchants and agents. They do eat much in the name of their valuable services. Mass-production must be matched by mass-marketing. This results in high costs. Moreover, as a co-ollary of keen competition, on the one-hand marketers have been trying to sell the commodities by improving marketing methods and by providing more and varied services to the consumers. On the other hand, society has also accepted to pay high prices in view of the valuable services that it is getting in return from the marketing system. As the life and living are getting sophisticated, the society is expecting too much from marketing mechanism, in terms of varied kinds of services, that is possible only at a high cost. Further the inefficiency that creeps in various marketing functions and segments, due to the presence of inefficient and incompetent men, results in higher costs of the marketing.

That is why, attention is now being paid to marketing, by all, both men of marketing and outsiders, like government, producers and educational institutions. Every effort is being made by these agencies to reduce the marketing costs. Thus, development of chain stores, multiple shops and departmental stores avoid middlemen. Co-operatives are developed to provide better services to society. Educational institutions are helping by turning out able and highly qualified marketing experts. At the same time, Governments of the nations are at work to provide and improve the social and economic overheads. They have to superfine infra-structure like communication systems, railways, water-ways and air-ways.

***Marketing as Science or Art:*** To know whether marketing is a science and/or an art, one must know what is meant by these two words. Science is a classified and systematized body of knowledge. Put in another way, to call anything as a science, it must be able to build up a body of laws or principles which can be relied upon to work over and over again. Science is a system of facts and principles concerning a subject. It is a rich fund of knowledge founded on experience and research that has set generalizations universally accepted. Naturally sciences can tell what is going to happen in the prescribed conditions of life, e.g., an eclipse can be forecast many years before it is due. Comet appearances can be predicted with accuracy. However, it does not mean that all natural sciences are very exact. Similarly, marketing, like any other natural science, does seek to build a body of valid laws and principles, e.g., the rise and fall in the consumer income, directly results in the fall or rise in sales of a retail organisation. The higher the prices lower will be the consumer demand.

Therefore, there is a substantial body of classified knowledge about marketing. Such generalizations render marketing a science. It may not be as exact as the formulae of Physics, Chemistry or Mathematics. Still, it provides sufficient reasons to believe that it has its own laws that can be accepted universally.

On the contrary, 'art' means the application or principles laid down to the practical life. It is the application or a set of rules or principles to practise. So, it can be said that application requires the skill, if there is no skill in the skull, every thing is nil: Business skill or acumen is to be developed or is to be practised to get perfected in the line. Modern marketing management is the art of getting things done from others to have smooth flow of goods. Marketing is an art, as substantial body of rules or principles on buying, selling, financing, risk-bearing, transport, storage, standardization and market information, have been put into practice, in order to make economic life a colourful success. Experts of modern marketing are of the opinion that through the development of marketing theories which will emerge as valid laws or principles, marketing will become more a science and less an art. However, it is one sided view. Not bothering about the tug between the experts, we conclude that marketing is both a science and an art, as it has the properties of science and attributes of an art.



## Approaches to the Study of Marketing

**Commodity Approach** : The 'commodity approach' refers to the detailed study of the problems encountered in marketing particular products that may be consumer, industrial or agricultural-products such as hair-oils, transistors, pens, paper, ties, clothing, lathe machines, bull-dozers, duffers, oil-engines, generators, wheat, rice, cotton, dairy-products etc. Number of problems crop up in the movement of goods from the point of production to the point of consumption. We may take up any type of product and study how each of them is marketed. This detailed analysis encompasses the study of classification of products, characteristics of each kind of product, source of supply, the persons engaged in exchange, its transportation, financing, storage and advertisement. For every product, we have to apply this criterion that becomes repetitive. Though there may be certain differences in marketing, most of the product similarities out-weigh the differences. By studying the products individually, we get the full picture of marketing.

**Institutional Approach** : This approach studies the various marketing institutions particularly the middlemen or facilitating agencies which perform the marketing functions. It emphasizes the type of middlemen and agencies involved. We are to study wholesaling, retailing and various other agent-middlemen at the distribution level. Under the title of wholesaling, we are to concentrate on the functions performed and services rendered by the group of these people, the problems that they face in the flow of goods. Retailing takes into account the study of nature and significance of retailing in terms of functions and services performed and rendered by retail institutions like departmental stores, multiple shops, supermarkets, mail-order houses, co-operatives, etc. In case of agent middlemen, we are to dig in about their functions and services, as they are essential adjuncts in the machinery of marketing. It is more or less a study of all those institutions that are instrumental in moving the wheels of marketing. It will cover institutions like, regulated markets, stock exchanges, commodity exchanges, banking and other organisations, including governmental institutions that provide legal base for marketing activities.

**Functional Approach** : The 'functional approach' refers to the classification and study of specialized activities which are performed in doing marketing work i.e., functions of marketing system. It analyses each function, in relation to the importance of its performance. The different marketing functions are, selling, buying, transportation, ware-housing, financing, risk taking and market-intelligence. All these functions are to be studied separately in order to understand their importance. To illustrate, we may study the selling function in relation to marketing of a particular product like a lathe-machine or rice or a T.V. Set etc., and as to how each of the different institutions, engaged in marketing of these products, perform the activities; that is the function of retailers, wholesalers, manufacturers etc. By careful investigation of how each of the functions of marketing are performed and what problems they face and how much they cost, we are able to obtain an understanding of marketing.

## MARKETING MIX:CHOICE OF MARKETING METHODS

A successful marketing strategy must have a marketing mix as well as a target market for whom the marketing mix is prepared. The elements or variables that make up a marketing mix are only four—

1. Decisions on product or service,
2. Decisions on price,
3. Decisions on promotion, and
4. Decisions on distribution.

These four ingredients are closely interrelated. Under the systems approach, the decision in one also affects action in the others. Marketing mix decisions constitute a large part of the marketing management.

In marketing planning we use marketing information to assess the situation. We have to select specific marketing targets in the form of market segments. For each segment or subdivision of the market we formulate a combination of a number of devices or types of marketing activities that are coordinated into a single marketing programme to reach a particular target or market segment. The combination of these marketing methods or

devices is known as the marketing mix. Marketing manager is a mixer of all marketing ingredients and he creates a mix/blending/ combination of all the marketing elements and resources. Marketing mix offers an optimum least cost combination of all marketing ingredients so that we can have realisation of company goals such as profit, return on investment, sales volume, market share and so on. It is a profitable formula of our marketing operations. The marketing mix will naturally be changing according to changing marketing conditions and also with changing environmental factors like technical, social, economic and political affecting each market. It is, of course, based on marketing research and marketing information. It must be fully related to customer demand, competition as well as other aforesaid environmental forces.

The Marketing mix can be conveniently grouped under the following four heads—

1. Product mix including aspects of packaging and branding.
2. Distribution mix including questions of warehousing and transportation facilities.
3. Pricing mix.
4. Promotion mix including personal selling and advertising.

Manufactures take to various policies to get success in the market. Marketing Mix is one of the important policies adopted by them. The benefit offered to the consumer is the main thing. The product itself constitutes the most important element of the marketing mix.

Closely tied to the product are its packaging and branding as a product along with its packaging and branding creates a particular image in the consumer's mind. Another element in the marketing mix of any firm is the system of marketing channels through which product and services are distributed to the ultimate consumers or final users. The basic object of the manufacturer in selecting and developing distribution channels in conjunction with other elements of the marketing mix is to maximize the degree of attainment of company goods including profit, stability and long-term growth. It should be emphasized that marketing channel policies are an integral part of the marketing mix and should be thought over on the basis of other marketing decisions. The marketing channel decision is affected by production and financial considerations. Another element of the marketing mix closely concerned with the marketing channel policies is pricing. In setting the prices, manufacturers must work backward from the final or retail prices, to a factory price with the allowance for customary or required margins at each stage of the channels. Finally, another important element of the marketing mix is promotion that includes advertising, sales promotion through contests and free gifts and the personal selling activities.

These four elements are known as "Four Ps" in marketing. The "Four Ps" classification of marketing decision variables was popularized by E. Jerome McCarthy. He termed them as the product, place, promotion and price. But here the "place" variable has been replaced by 'Physical Distribution' as it is thought to be more suitable with the other three Ps. These "Four Ps" should be directed towards the buyer or customer and here, only, marketing research supplies the information needed by persons who are incharge of Planning the "Four Ps" with reference to customers. A list of the relevant market forces and the elements of the marketing mix would prove to assist in analyzing marketing problems. The chief goal of all marketing activities is 'Profitability'. Hence, the marketing manager should plan such a marketing mix that will give the optimum profit for the goods, he has to market. He should plan the marketing mix keeping in mind the relevant market forces so that the results would give sufficient and proper profits. About this the ex-Prime Minister of Britain W. Churchill put up that "it is a socialist idea that making profits is a vice, I consider the real vice is making losses".

Some marketing experts indicate seven ingredients, in the formulation of marketing mix: Thus, additional three ingredients are—

1. Packaging.
2. Perception.
3. Persistence.

It has made in all 7 P's of the marketing formula.

Under packaging, Plastic package has assumed new importance in self-service retailing. Perception is a faculty of insight enabling a marketing manager to discover and seize the hidden marketing opportunity, e.g., the 'hook' of clove in tooth pastes and tea bags and ayurvedic ingredients in cosmetics. Persistence is the necessary attitude to assert one's strong will against all odds. The entire marketing team must be self-motivated team to demonstrate persistence. For instance, a small company marketing Promise tooth paste adopted a will to do or die and in spite of high pressure selling, advertising onslaught and legal hurdles from multinationals/Colgate it has come upto No. 2 position only in a matter of five years. So without perception and persistence, marketing mix of a new product can only be a failure.

### **ELEMENTS OF MARKETING MIX :—**

(a) General Planning :

- (1) Establishment of an acceptable and possible rate of growth.
- (2) Determination of the size and extent of Market where business may function profitably.
- (3) Determination of the costs and expenses needed for the business operation.
- (4) Estimation of the needed finance.

(b) Product Planning :

- (1) Determination of the product or service offered.
- (2) The possible improvement and innovation in the product.
- (3) The brand and packaging policies.
- (4) The importance of servicing and after-sales service.

(c) Pricing :

- (1) The level and psychological aspects of prices.
- (2) The appropriate margin.
- (3) Resale price maintenance.
- (4) Government control, if any.

(d) Channels of distribution :

- (1) Sales through wholesalers.
- (2) Appointment of sole selling agents.
- (3) Sales directly, through own sales force.

(e) Sales Force :

- (1) The extent of sales-personnel.
- (2) The extent of approach to wholesalers and retailers.
- (3) The extent of approach to consumers, directly.

(f) Advertisement and sales promotion :

- (1) The advertisement programme.
- (2) The importance given to display a point on sale-material.

- (3) The extent of sales promotion aimed at consumers.
- (4) The extent of sales promotion to dealers.

(g) Physical Handling :

- (1) Transportation.
- (2) Warehousing.
- (3) Inventory Policies.
- (4) Possible reduction in cost.

(h) Marketing Research :

- (1) Sales analysis.
- (2) Field Surveys.
- (3) Use of outside Agencies.

The Four elements of marketing mix are equal, inter-dependent and essential. The marketing mix acts as the integrated marketing strategy and the four elements together constitute the marketing strategy.

Individually the four elements are important but their significance lies in the proper mix or blend indicating the unique way they are combined as a careful plan, or strategy, to meet competition in a dynamic marketing. For one market segment we have a typical marketing mix.

The decision on the four elements of marketing mix must be properly co-ordinated and balanced in order to achieve an optimum marketing mix.

A thorough grasp of the customer is common to all the four elements. The marketing mix is expected to provide maximum customer satisfaction.

Marketing Management cycle involves :—

1. Determination of the present and potential customer through marketing research.
2. Formulation of marketing plan and policy.
3. Development of product and its adaptation to specific customer needs through product planning and development.
4. Channel choice and channel management.
5. Physical distribution arrangements.
6. Generation and stimulation of demand through all devices of promotion.
7. Determination of selling prices and discounts.
8. Selling activities, i.e, personal selling, contract negotiation, payment provisions.
9. After-sale activities.
10. Feedback of information from the market on post-sale reactions and usage.
11. Repanning on the basis of feedback information from the environment and the market.

**Relationship with other Sciences :**

The marketing manager faces many difficulties because of the necessity of integrating the several variables of the marketing mix. Marketing management comes across again further challenges. The marketing manager should also be able to use to the benefit of the concern the concepts and ideas, given by the economics, psychology, sociology, anthropology, mathematics and statistics. He can better use these subject experts in his job of marketing

management as he is not a specialist in all these fields. These sciences have given the management methods like projective techniques, mathematical models and programming, statistical sampling and measurement. These all behavioural sciences give to the marketing manager many clues for his programming and activity. Products are purchased due to habit, impulse, social pressure, prestige. Like a psychologist, the marketing manager is also interested in personality, attitudes and motives of human beings. Hence, the marketing manager should be in a position to use, where relevant, the ideas advanced by other sciences.

“Four Ps in the marketing” with the help of marketing research can be used to plan programmes aimed at influencing social ideas. The product variable helps in fulfilling the needs and wants of target groups of consumers by business houses by proper designing of products and services. In Social marketing, target audiences should be studied and proper products or services designed by the seller so that the target audiences find it desirable to purchase the product or service.

## MARKETING MIX ORGANISATION

A marketing organisation may be based on the product lines. It may be around a group of customers. When we have a national market and regional problems demand special attention, organisation by territory may be preferred.

Usually we have the functional approach to devise a marketing organisation. Under the functional view, the functions to be performed determine the form of the organisation and also its structure.

Marketing organisation by functions is based on the important marketing functions, such as selling, marketing research and information, advertising, sales promotion, physical distribution, branding, packaging, pricing and channel choice, product planning and development, marketing planning and controlling, etc. A typical marketing staff of a company might be composed of : (1) A Marketing Manager or director or vice-president-marketing, (2) A sales manager, (3) An advertising manager, (4) A marketing service manager, (5) A physical distribution manager, (9) A product or brand manager and (7) An office manager.

**Marketing Manager/Director:** It is a top management position. As a director of marketing or marketing manager, he is responsible to carry out all the marketing activities within the firm and of coordinating these with other company functions. The major responsibilities of a marketing manager are : 1. Search of the environment for marketing opportunities, 2. Determination of marketing plans, policies and procedures in consultation with the managing director, 3. Evolving marketing mix for each market segment, 4. Supervision and control over sales manager, advertising manager, product manager, distribution manager, marketing services manager, etc who are directly responsible for implementing the marketing programme, 5. Negotiating transactions and pricing, 6. Growth of existing markets, 7. Development of new products, new markets, new channels, new innovations in the field of marketing, 8. Marketing control and modifications of marketing policies, policies and programmes, 9. Control over marketing costs, 10. Consumer and public relations, 11. Selection, management and control of distribution channels, 12. Sales Promotion and marketing communications, 13. Management of change due to changing competition, changing customer needs, etc.

**The Sales Manager:** He looks after the management of sales force. He directs, motivates and controls selling activities. He negotiates sales contracts. He is in charge of the sales campaign.

**The Advertising Manager:** He is responsible for management of advertising and sales promotion programme. He is in charge of the advertising campaign.

**The product or Brand Manager:** Product or brand manager is the new marketing man responsible for coordinating all company efforts on behalf of his assigned products. He is a special officer responsible for sales of his products. He recommends branding, packaging and labelling. He advises on pricing, distribution, sales and advertising programmes for his product line. Thus he is a staff specialist dealing with all phases of marketing. He advises all other departments. He is mainly responsible to ensure unified and coordinated marketing efforts.

**The Marketing Services Manager:** He is in charge of : 1. Marketing information and research, 2. marketing planning, 3. research and development. Marketing information and research provides essential information for use in planning, developing, producing, and selling the products or services of the company. Under the customer-oriented marketing approach, all marketing decisions are based on information supplied by the staff specialists. Marketing planning and control is the nerve centre of the organisation. Under the current marketing practices, the marketing planning is usually performed in the marketing departments of the business enterprises. Marketing information and research is a powerful decision making tool at the service of the marketing manager. Marketing research is a valuable asset in evaluating the effectiveness of each element of marketing mix. All marketing problems are solved with the help of staff specialised in marketing information and research. Marketing information facilitates planning and control function in the areas of product, distribution, promotion, and pricing, i.e., in each element of marketing mix. One of the main functions of marketing information system is to provide the mechanism (feedback information) for marketing control.

**Physical Distribution Manager:** The physical distribution manager is in charge of physical distribution activities (logistic activities) such as transportation, warehousing, material handling, protective packaging, inventory control, order processing, customer services, and so on. Physical distribution covers the marketing functions performed by channels of distribution, i.e. management of distribution channels and the management of the physical flow of goods from the firm to its customers.

**Office Manager:** He is in charge of the office organisation and management. He looks after all paper-work relating to marketing activities particularly arising out of selling and physical distribution. He has also to look after paper-work arising out of relations with customers, public and government.

Marketing executive understands buyers' wants, buying influences, channels, and competition. He is able to use product features, personal selling, advertising and sales promotion, price, and after-sales service to stimulate purchasing behaviour. Modern marketing philosophy stresses the profit concept, not the volume concept. Profitless volume or volume-for-the sake-of-volume-alone concept is to be discarded under the marketing concept.

In a modern marketing organisation we may have many additional departments or units such as new venture department for searching and developing innovations, operations research unit to work specifically on marketing problems, a separate department to look after consumer, trade and government relations activities. A socially responsible marketing firm should have a separate public relations department.

Marketing has been viewed as an ongoing or dynamic process involving a set of inter-acting activities dealing with a market offering multi-products and substitutes to consumers on the basis of reliable marketing anticipation (sales or demand forecasts). Marketing is a matching process by which a producer provides a marketing mix (product, price, promotion and physical distribution) that meets consumer demand of a target marketing within the limits of society. The process is based on corporate goals and corporate capabilities. Marketing process brings together producers and consumers—the two main participants in exchange. Each producer or seller has certain goals and capabilities in marketing his products. He uses marketing research as a tool to anticipate market demand. Then he provides a marketing mix (product, service, promotion, advertising, pricing distribution, etc.) in order to capitalise marketing opportunity. An exchange or a transaction takes place when market offering is acceptable to the customer who is prepared to give something of value (money) in return against the product so bought. In the process of exchange both give up something and both gain something in return. The producer gets the surplus value in the form of profit which is a reward for delivering customer satisfaction. The consumer gets the surplus value in the form of utility or individual satisfaction. Market mechanism brings together a willing seller and a willing informed buyer for mutual gain. The marketing process is influenced by competition, government rules and policies, mass-media of communication, consumer advocates, etc. Marketing environment affects both producer and consumer. The business enterprise engaged in the marketing process itself is influenced by social environment. It consists of political, economic, social, cultural and technological forces. The Marketing people have to adapt with these ever changing environmental forces and fulfil the needs and desires of the society or 'community'. Thus, marketing is an economic as well as social activity. In the long run, society must



approve the marketing process. It must monitor marketing process and control its effectiveness. Please note that the modern business enterprise is called upon to demonstrate simultaneously higher level of economic performance and fulfilment of social responsibility, i.e., high level of consumer/citizen welfare and satisfaction. Marketing process must reflect social awareness and social responsiveness, and we must have judicious combination of productivity and social responsibility in all business enterprises. Then only we shall have assured survival, growth and prosperity of our units. In essence, marketing is the business function charged with responsibility for directing the firm's response to an ever-changing market environment and orienting all parts of the business towards the sole purpose of the business viz., the creation of satisfied customers while earning a reasonable and acceptable profit.

The marketing process involves three major activities : 1. Concentration, 2. dispersion, and 3. equalisation. The first aspect of the two-fold flow of products is concentration. The second aspect is dispersion towards the consumer or user of those products, which have been concentrated at the central markets. Between these two types of flows of products we have the activity of equalisation. The process of equalisation involves proper adjustment of supply at all centres of distribution in the light of current market conditions. Supply of goods has to be adjusted to demand on the basis of time, quantity and quality. Transport equalises supply-wise and warehousing equalises in time-wise. The assembled stock of goods is subdivided or broken into smaller lots required to meet the needs of retailers and consumers. Concentration, equalisation and dispersion constitute the heart of marketing.

Marketing management is directly in charge of formulating the marketing mix and conducting the marketing process. Marketing management is in charge of planning, organising, directing and controlling the marketing of goods and accomplish the overall marketing objective, viz. profitable sales with satisfaction of consumer demand.

Marketing research is the starting point in the marketing process to ascertain and identify customer needs and desires through a market analysis and investigation. Resources of men, money, materials and management are employed in the marketing system to perform marketing functions and thereby achieve the satisfaction of customer demand (the purpose or mission of marketing). Marketing process covers marketing functions as well as marketing agencies or channels of distribution. Marketing management operates through marketing agencies or institutions for distribution of goods in the market.

1. On the basis of selling area, we have local, national and international markets, 2. On the basis of articles of trade, we have product markets, e.g. cotton market, bullion market, 3. On the basis of nature of exchange dealings, we have spot or cash market and futures or forward market, 4. On the basis of nature of goods sold, we have consumer goods market and industrial goods market. 5. On the basis of period, we have short-term and long term markets e.g. money market for short-term funds and capital market for long-term funds. 6. On the basis of nature and magnitude of selling, we have wholesale and retail markets.

There are three kinds of goods : 1. Manufactured goods, 2. Agricultural goods and 3. Natural raw materials.

Manufactured goods may be consumer goods needed for use or consumption by consumers or industrial goods needed for use by producers in the process of production. Agricultural goods may be in the form of raw materials for industry or consumer goods for immediate consumption. Natural raw materials are the free gifts of nature and they are the raw materials of industry.

Prof. M.T. Copeland developed three-fold classification of consumer goods based on typical buying habits of the consumers : 'how', 'when' and 'where' consumers usually buy commodities. The three categories of consumer goods are : 1. Convenience goods, 2. Shopping goods, 3. Speciality goods.

1. **Convenience goods** : These goods are demanded by customers frequently in small quantities, but they must be immediately available at easily accessible retail shops. These are low-cost, highly advertised items that are designed for mass markets and are sold to all income classes. All sales



promotion devices are liberally used to stimulate consumer demand. They are branded, low-priced goods sold on a self-service basis. They have to be distributed through numerous retail outlets. Examples of convenience goods are newspapers, food articles, soaps, etc.

2. **Shopping goods** : There are two types of shopping goods : (1) Fashion goods and (2) Service goods. These goods need search efforts and special visits to central markets; these are not urgent purchases, buyers can postpone buying according to their convenience. They need not have numerous retail outlets. Buyers want to shop around and select goods after comparing quality, terms, style, price, services, and so on. Examples of these goods are furniture, jewellery, domestic appliances, draperies, etc.
3. **Speciality goods** : They are goods with unique features. They demand special shopping efforts. They are sold in speciality shops. Buyers have brand preference and insistence and will make special efforts to buy these. These goods are, e.g., radio, TV Set, watches, fancy groceries, cars, tape recorders, ect. Many well-known and very popular brands also become speciality goods.

The circle of exchange represents the market to conduct the process of exchange wherein products are changed against money/other products (i.e. barter/exchange).

In the market, ownership and possession of products would be transferred from the seller to the buyer as per the sales contract. Factors affecting the exchange process in the market are : (1) demand and supply, (2) price, (3) market information with the buyers and sellers, (4) legal control and regulations to ensure fair trading. Feedback information indicates buyer's post-purchase experience. If satisfied seller gets repeat orders. If dissatisfied, the buyer will buy other brands.

**Conclusion** : Besides the general planning in a business concern, the marketing is regarded as a more important function while planning for the production of a product. It deals with pricing strategy, packaging, physical distribution and its promotion. These four factors are regarded as 'Four Ps' in marketing.

Promotion includes advertising, sales promotion, and management of the sales force. All of them are more directed towards selling. It means to increase sales volume.

These four variables or factors are known together by the term 'Marketing Mix'.

Becoming consumer-oriented and being in a position to direct the elements of the marketing mix effectively to the end consumers needs marketing research.

It is concerned with gathering of the relevant facts.

The modern thinking is to apply the same modern marketing approach when marketing a social service like the family planning in India. In this way, the 'Four Ps' can be equally effective in social marketing also.

Marketing mix is also related to other sciences like economics, psychology, sociology, anthropology, mathematics and statistics. They have given various measurement methods.

Again, factors like habits, impulse, social pressure, prestige, etc., all help the marketing manager in evolving a marketing strategy.

\*\*\*\*\*

## LESSON 2

---

# MARKET SEGMENTATION

---

### Nature and Significance of Market Segmentation

Market segmentation strives for successful attainment of organisational objectives by identifying and serving groups of people with similar wants. It is a compromise between the inefficiency of treating all consumers alike and the inefficiency of treating each one differently. Whenever a market for product or service consists of two or more buyers the market is capable of being segmented. Market segmentation is the subdividing of a market into homogeneous subsets of customers, where any subset may conceivably be selected as a market target to be reached with a distinct marketing programme. The power of this concept is that in an age of intense competition for the mass market, individual sellers may prosper through creatively serving specific market segments whose needs are imperfectly satisfied by the mass market offerings.

The concept of market segmentation is based on the fact that markets, rather than being homogeneous, are really heterogeneous. No two buyers or potential buyers of a product are ever identical in all respects. However, large groups of potential buyers share certain characteristics of distinctive significance to marketing, and each such group constitutes a market segment. Existence of a group of individuals with common characteristics, however, does not in itself constitute a market segment. Only when they have common characteristics as buyers then it constitutes a market segment. By grouping such individuals into market segments, a degree of homogeneity is attained, making it possible to tailor optimal marketing strategies to each segment.

### Segmentation Criteria

Segmentation strategy uses the following four criteria :

- (a) **Identity** : The marketing manager interested in segmentation must have, first of all, some means of identifying members of the segment—some basis for classifying an individual as being or not being a member of the segment. That is, there must be some evident want or desire, or at least some common characteristic or behaviour pattern.
- (b) **Accessibility** : Once a segment has been identified, the next question is : Can we communicate with them ? The organisation must be able to focus its marketing efforts on the chosen segment.
- (c) **Responsiveness** : If the segment can be identified and communicated with then the next criterion to consider is whether or not the segment will respond to marketing effort. For example, certain product features, a lower price or more service, may more precisely satisfy the needs of a given segment than would a general marketing effort.
- (d) **Significance** : Suppose that a segment meets the first three criteria i.e. it can be identified, reached with marketing effort, and would respond to that effort. The last and the most crucial question from marketing management's point of view is : Is it really significant ? The segment must possess sufficient buying power (willingness and ability to buy) to make a worthwhile contribution to the marketing organisation's objectives.

### Benefits of Segmentation

The seller who is alert to the needs of different market segments may gain in three ways; First, he is in a better position to spot and compare marketing opportunities. He can examine the needs of each segment against

the current competitive offerings and determine the extent of current satisfaction. Segments with relatively low levels of satisfaction from current offerings represent excellent marketing opportunities.

*Second*, the seller can use his knowledge of the *marketing response differences* of the various market segments to guide the allocation of his total marketing budget. The ultimate bases for meaningful segmentation are differences in customer response to different marketing tools. These response differences become the basis for deciding on the allocation of company marketing funds to different customers.

*Third* the seller can make finer adjustments of his product and marketing appeals. Instead of one marketing programme aimed to draw-in all potential buyers, the seller can create separate marketing programmes aimed at the needs of different buyers.

### **Bases for Segmenting markets**

A large number of variables can be used to segment a market. We can classify them into four categories :

(A) Geographic variables. (B) Demographic variables. (C) Psychographic variables. (D) Buyer-behaviour variables.

On the basis of these variables we can have the following forms of segmentation :

(1) Geographic segmentation. (2) Demographic segmentation. (3) Psychographic segmentation. (4) Benefit segmentation. (5) Volume segmentation. (6) Marketing factor segmentation. (7) Product space segmentation.

(1) **Geographic segmentation** : In this form of segmentation, sellers distinguish carefully among the regions in which they can operate and choose those in which they can enjoy a comparative advantage. A small retailer may distinguish between neighbourhood customers and more distant customers. A local fertilizer salesman may distinguish between city customers and rural customers. A national manufacturer can classify his customers by sales territory and each state like U.P., M.P. and H.P. may represent one sales territory.

In all these cases, the geographical units become the basis of differentiated marketing effort.

(2) **Demographic segmentation** : In this form of segmentation, sellers attempt to distinguish different groups on the basis of demographic variables such as age, sex, family, size, income, occupation, education, family life cycle, region, nationality, or social class. Demographic variables have long been the most popular bases for distinguishing significant groupings in the market. One reason is that these variables correlate well with the sales of many products; another is that they are easier to recognize and measure than most other types of variables.

(3) **Psychographic Segmentation** : In this form of segmentation, the basic idea is that buyer's needs may be more differentiated along life-style or personality lines than along straight-forward demographic lines. Thus, there are the swingers, who seek up-to-date foods and fast paced, hedonistic living. Status seekers, who try to buy goods that will get them a high status in society, and plain and simple people, who seek ordinary, untrilled goods that do their job—one implication of differentiating buyers along personality is that they can be reached with different marketing programmes, and further the organisational objectives can better be served in the wake of serving their needs with the required attention and care. For example, because of their unique features swingers will respond to costlier goods more favourably than the ordinary people. Various research studies have been conducted in the U.S.A. and other advanced nations to test the validity of this psycho-segmentation. These studies have been directed from time to time at whatever different consumer formalities are attached to different products which have different images. Each product needs to be studied separately for the possible strength of personality factors in the purchase behaviour. The theoretical connections between product images and personality types remain to be worked out better.

Even where evidence is found of personality differences in the purchase behaviour, the implications for marketing strategy are far from clear.

(4) **Benefit segmentation** : In this form of segmentation, buyers are sub-divided in relation to the various benefits which they expect from a particular product. A sample of consumers are interviewed for this purpose. In the case of toothpaste, for example, there are customers who seek decay prevention, bright teeth, taste or low price. The idea behind benefit segmentation is very simple —the company can choose the benefit it wants to emphasize, create a product that delivers it, and direct a message to the group seeking that benefit. For example in our country, makers of Colgate have repeatedly been emphasizing that 7 out of 10 users of Colgate benefited (avoided tooth decay). At the same time we also find that Colgate makers have been emphasizing the importance of bright teeth, when they show an advertisement on TV about a young unmarried couple—before use and after use. So the idea is that by choosing different benefits, which potential buyers of a particular product expect from that product, the company in the ultimate analysis can have a larger volume of sales.

(5) **Volume segmentation** : In this form of segmentation, seller distinguishes the heavy, medium, light and non-users of his product. Then he accepts to determine whether these groups differ in demographic or psychographic ways. In particular, he is interested in the characteristics of the heavy-user group. But he should give thought to other volume groups also, because they may present different opportunities. So the idea behind this volume segmentations is quite simple, though the actual attempt to identify different volume groups may be a bit complicated and difficult. This is a general remark and can practically be taken for almost every form of segmentation,

An important implication of volume segmentation for marketing management is that by identifying volume groups, the seller can approach each volume group with a distinct marketing programme and thereby increase the total satisfaction provided by his product to different buyers. Needless to say that it will result in increased sales and profits.

(6) **Marketing-factor segmentation** : In this form of segmentation, the seller attempts to subdivide the market into groups responsive to different marketing factors, such as price and price deals, product quality, retail advertising, and so on. The idea is that if a manufacturer, for example, knows that one identifiable group of his customers was more responsive to changes in advertising expenditures than others, he might find it advantageous to increase the amount of advertising expenditures than others, he might find it advantageous to increase the amount of advertising aimed at them. The same sort of tailoring might also not be appropriate if it was found that customers reacted differently to changes in pricing, packaging, product quality and like.

(7) **Product space segmentation** : In this form of segmentation, buyers are asked to compare existing brands according to their perceived similarity and in relation to their ideal brands. Through non-metric multidimensional scaling, the analyst infers the latest attributes that consumers are using to perceive the product class. Next, through cluster analysis, the respondents are classified into different clusters, internally homogeneous but quite different from cluster to cluster. Each cluster of respondents perceives the product in a distinct way or has a distinct ideal brand. Then the analyst sees whether the different clusters have distinctive demographic or psychographic characteristics. If so, he has found ‘natural’ segments based on different product perceptions or preferences.

The main conclusion from this discussion of market segmentation is that the seller may proceed to segment his market in many different ways. His goal is to determine the most decisive mode of segmentation—that is, the differences among buyers that may be the most consequential in choosing among them or marketing to them.

## **Segmentation Strategy**

Segmentation strategy begins with the selection of the target market. The term target market refers to those segments upon which the marketing effort will be found. This involves matching the characteristics of both the segment and the marketing organisation. Once the target market is selected, a marketing programme for reaching this market is formulated in terms of marketing mix decisions and the integration of these decisions. Then the programme is implemented in the market place and control procedures are instigated. The following figure summarises the process of strategy formulation :

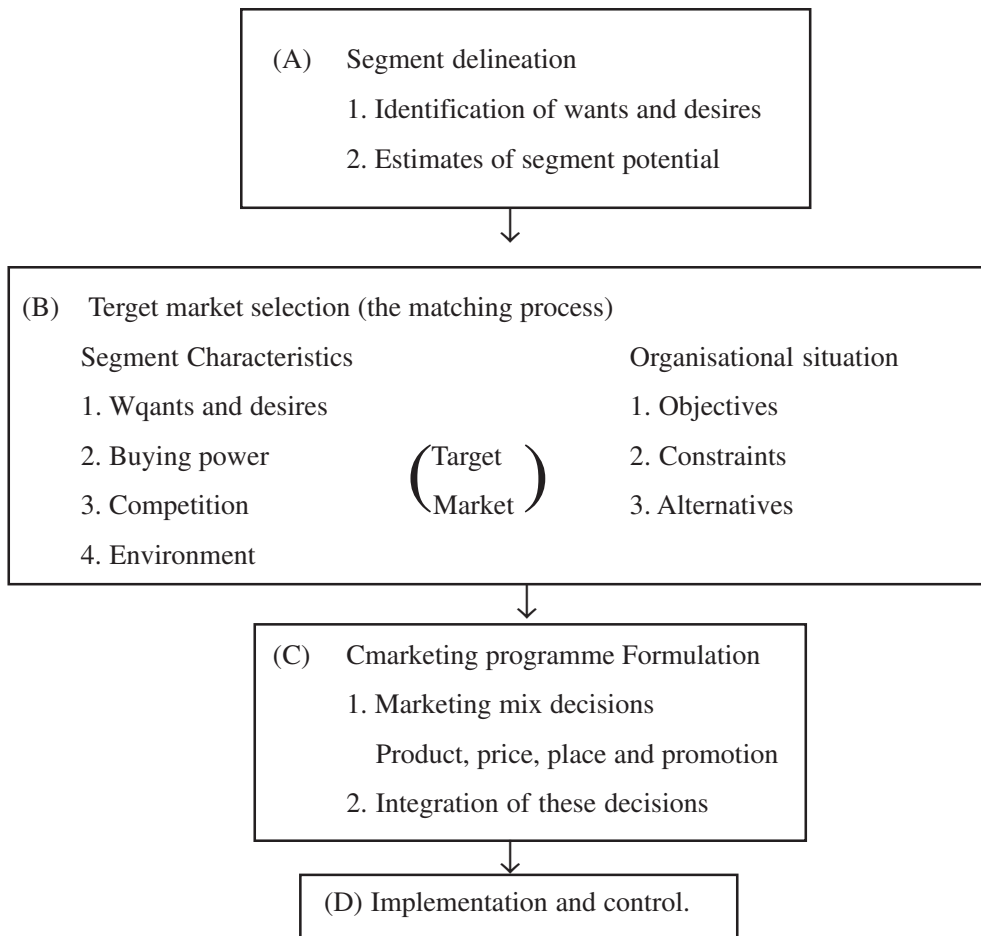

### Alternative Strategies of Market Segmentation

Every market can be segmented, to some extent, since the buyers who compose it are never alike. However, a firm may or may not wish to shape its marketing strategies around these differences.

In fact, three different strategies are available. The firm may put out only one product and try to draw in all buyers with one marketing programme. This can be called undifferentiated marketing. Or it may design separate products and/or the marketing programmes for each segment. This can be called as differentiated marketing. Finally, it may concentrate all its efforts in one or a few lucrative segments of the market. This can be called concentrated marketing.

(A) **Undifferentiated Marketing** : Under this strategy the firm chooses not to recognize the different demand curves that make up the market. Instead, it treats the market as an aggregate, focusing on what is commonly the needs of people rather than on what is different. Examples are Coco Cola and cigarettes.

Under this strategy, the firm tries to design a product and a marketing programme that appeal to the broadest number of buyers. It relies upon the mass channels, mass advertising media, and universal channels.

Undifferentiated marketing is primarily defended on the grounds of cost economies. The undifferentiated advertising programme enables the firm to enjoy media discounts through large usage. The absence of

segmental marketing research and planning lowers the costs of marketing research and executive overhead. On the whole, undifferentiated marketing results in keeping down several costs of doing business.

(B) **Differentiated Marketing** : Under this strategy, a firm decides to operate in several or all segments of the market but designs separate product and/or marketing programmes for each. A firm following this strategy tries to produce a product for every purse, purpose and personality, for example General Motors in U.S.A. By offering product and marketing variations, the firm hopes to obtain higher sales and a deeper position within each market segment. It hopes that a deep position in several segments will strengthen the customer's overall identification of the company in the product field. Furthermore, it hopes for greater loyalty and repeat purchasing, because the firm's offerings have been bent to the customer's desire rather than the other way round.

Today cigarettes are manufactured in a variety of lengths and filter types. The consumer often has the option of buying his favourite brand filtered or unfiltered, or long or short. Earlier, when cigarette manufacturers adopted undifferentiated marketing, the question of customer's choice simply did not arise. The net effect of differentiated marketing is to create more total sales than undifferentiated marketing. But one thing should be kept in mind, that is, differentiated marketing is likely to produce more company sales but at the price of creating higher company costs. Therefore, nothing can be said in advance regarding the relative optimality of this strategy. Yet the literature is full of implications that differentiated marketing is more nearly optimal. All that can be said is that differentiated marketing is sales-oriented, and this explains why marketing men like this strategy. But whether it is profit oriented depends upon whether it can cause sales to rise more than the costs.

(C) **Concentrated Marketing** : Both undifferentiated and differentiated marketing imply that the firm goes after the whole market. However, many firms see a third possibility, one that is especially appealing when the company's resources are limited. Instead of going after a small share of a large market, the firm goes after a large share of one or a few sub-markets.

Through concentrated marketing the firm achieves a strong market position in the particular segment it serves, owing to its greater knowledge of the segment's needs and the special reputation it acquires. Furthermore, it enjoys many operating economies because of specialisation in production, distribution, and promotion. If the segment of the market is well chosen, then the firm can earn high rates of return on its investment. Concentrated marketing, however, involves company's future growth to one segment of the market and this carries obvious risks. One possible risk is that demand may continue but other companies enter the same segment and cause a decline in the profits.

## Selecting a Marketing Strategy

Among other things, the most important characteristics for selecting a strategy are the following:

- (a) **Company resources** : If the firm's resources are too limited to permit complete coverage of the market, its only realistic choice is concentrated marketing. But where resources permit, the firm can have a choice between differentiated and undifferentiated marketing.
- (b) **Product homogeneity** : Product homogeneity refers to the invariance of the product's characteristics. Most consumers do not perceive differences in such basic commodities as salt, grape fruit or steel. An undifferentiated marketing strategy for such products is, therefore, more natural than a differentiated or concentrated marketing strategy. On the other hand, products that are capable of great variation, such as cameras and automobiles, are more naturally suited to differentiation or concentration.
- (c) **Product stage in the life cycle** : This factor makes a difference, especially at the extreme stages of market introduction and market situation. When a firm introduces a new product into the market



place it usually does not find it practical to introduce more than one, or, at the most, a few product versions.

Its interest is to develop primary demand, and undifferentiated marketing strategy seems the suitable strategy. The firm may alternatively develop the product for a particular segment of the market and concentrate its efforts there. As the product moves through its life cycle towards the saturation stage, the firm starts to search harder for new and untapped needs in order to maintain or increase sales. Thus in the mature phase of the product life cycle, firms tend to pursue a strategy of differentiated marketing.

- (d) **Market homogeneity** : This refers to the degree to which customers are alike in their needs, preferences, and characteristics. In such markets segmentation would be some-what forced. Thus, the firm could try to stimulate customers to have more diverse preferences, but, in general, homogenous markets are best tapped by an undifferentiated marketing strategy. Conversely, heterogeneous markets can be tapped by either differentiated marketing or concentrated marketing.
- (e) **Competitive marketing strategies** : This factor refers to what competitors are doing when competitors are practising active segmentation, it is hard for a firm to compete through undifferentiated marketing. It would lose most of the battles. On the other hand, when competitors are practising undifferentiated marketing, a firm can often gain by practising active segmentation.

**Conclusion** : The conclusion of the foregoing discussion is that no particular strategy is superior to others in all circumstances. There can be under-differentiation, over-differentiation, or over-concentration. Much depends on factors such as company resources, product homogeneity, product stage in the life cycle, market homogeneity and competitive marketing strategies.

## **THE CONCEPT OF A PRODUCT AND PRODUCT LIFE CYCLE**

The word “product” has several meanings. According to Kotler, “A product is anything that can be offered to a market for attention, acquisition, use, or consumption; It includes physical objects, services, personalities, places, organisations, and ideas.”

In a very narrow sense, a product is a set of tangible physical attributes assembled in an identifiable form. Each product carries a commonly understood descriptive name, such as, steel, shoes, etc. In this narrow definition, product attributes appealing to consumers buying patterns have no part to play. On the contrary, a broader interpretation defines each brand as a separate product. For instance, in toothpastes, Promise, Colgate, Forhans, etc. are different brands. But the brand name suggests a product difference to the consumer, and this brings the concept of consumer want-satisfaction into the definition.

Besides, any change in the physical Features (design, colour, size, packaging), however minor it may be, creates another product. Further the concept of a product now also includes services accompanying the sale. All these features of a product can be combined. Therefore we can say that a product is a set of tangible and intangible attributes, including packaging, colour, price, manufacturer’s prestige, retailer’s prestige, and manufacturer’s and retailer’s services, which the buyer may accept as offering want-satisfaction. Thus, a product is more than a thing.

### **Product Line and Product Mix**

Product line refers to a group of products that are closely related because they satisfy a class of needs, are used together, are sold to the same customer groups, are marketed through the same type of outlets, or fall within a given price range. Wearing appareils are one example or a product line. But in a different context, say, in a small speciality shop, men’s furnishings (shirts, ties and underwears) and men’s ready-to wear (suits, sport jackets,



topcoats, and slacks) would each constitute a line. Similarly, men's apparel is one line, as contrasted with women's apparel.

The product mix is the list of all products that are offered for sale by a firm or a business unit. The product mix has three dimensions :

- (a) **Width** : The width of the product mix refers to the number of different product lines found within the company. For example, Bajaj Electricals produce a variety of electrical appliances such as fans, mixers, lamps, press, etc.
- (b) **Depth** : The depth of the product mix refers to the average number of items offered by the company within each product line. For example, Bajaj Electricals manufacture different varieties of models of fans and lamps.
- (c) **Consistency** : The consistency of the product mix refers to the close relationship of various product lines either to their end users, or to production requirements or to distribution channels, or to other variables. For example, Bajaj Electricals produce those goods which fall under the category 'Electrical Appliances'. So there is consistency in their products. In contrast to this, Godrej offers inconsistency in their product lines, manufacturing processes and even in their channels of distribution. For example, soaps and locks have no common relationship.

### **Factors influencing product mix**

In India the fundamental reason for changing product mix (adding or eliminating products) is the change in the market demand. Change in demand occurs due to the following factors :—

- (a) Population increase,
- (b) Changes in the level of the income of the buyers,
- (c) Changes in consumer behaviour,
- (d) Marketing influences,
- (e) Production influences,
- (f) Financial influences.

### **Major Product-Mix strategies**

The main such strategies adopted by manufacturers and middlemen in managing their product mix are discussed below :—

1. **Product modification** : It refers to a deliberate alteration in the physical attributes of a product or its packaging. For example, due to changes in fashion, dresses may have to be changed.
2. **Product elimination** : The products which can not be improved or modified to suit the market, are withdrawn. This process of withdrawal is known as product elimination.
3. **Expansion of Product mix** : It is also known as diversification. In order to utilise the marketing opportunities, a firm may expand in both width and depth. The expansion of the product line is undertaken by increasing the lines and/or items of products. New lines may be related or unrelated to the present products. For example, manufacturers of radio sets may start producing television sets and tape recorders.
4. **Contraction of product mix** : This strategy is to thin out the product mix, either by eliminating an entire line or reducing the number of product items in the line. The shift from fat and long lines to thin and short lines is designed to eliminate low-profit products and to get more profits from fewer products. This decision of contraction might be due to the purposeful act of the management to

suspend the production of unprofitable products. Marketing problems also compel the Manufacturers to withdraw certain items.

### **The optimal product mix**

The basis for defining the optimal product mix is the company's objectives. The current product mix is said to be optimal if the company's chances of achieving its objectives can not be enhanced, whatever adjustment is made in the product mix. For example, if the company's objective is primarily profit maximisation, then the product mix is optimal if profits could not be improved by deleting, modifying, or adding products. Similarly, if the objective is primarily sales growth, then the product mix is optimal if it yields a rate of sales growth that could not be profitably enhanced by any product-mix changes. Typically there are many objectives, and this complicates the problem of defining an optimal product mix.

**Symptoms of suboptimality of product mix :** Any of the following conditions suggests that a current product mix might be less than optimal :—

- a. Excess productive capacity on a chronic or seasonally recurring basis.
- b. Disproportionately high percentage of total profits from a few products.
- c. Insufficient products width to exploit sales-force contacts efficiently.
- d. Steadily declining sales or profits.

According to the condition prevailing in the company, it should try to obtain optimal product-mix by adopting suitable product-mix strategy.

## **PRODUCT LIFE CYCLE (PLC)**

Like people, products go through a life cycle. Therefore it is essential that a company concentrates on the product-planning activity. The product life cycle is an attempt to recognise distinct stages in the sales history of the product. There are distinct opportunities and problems corresponding to these sales stages with respect to marketing strategy and profit potential. By identifying the stage that a product is in or is headed forward, perhaps better plans can be formulated.

### **Stages in the Product Life Cycle**

From birth to death, a product's life can be divided into four major stages which are as follows:—

1. Introduction, 2. Market growth, 3. Market maturity, 4. Sales decline.

A product's marketing mix must change during these stages, because :-

1. Customers attitude may change through the course of the product's life cycle.
2. Entirely different target markets may be appealed to at different stages in the life cycle, and
3. The nature of competition moves towards pure competition.

In addition, the sales history of the product varies in each of its four stages, and the profits also change. But it is important to note that the two do not necessarily move together, profits may decline while sales rise. Their general relationship can be seen below :—



The above figure tells that the life-cycle stages cover nearly equal periods of time, although actually that is not the case. The different stages in any given product's life cycle usually last for different periods of time. Also, the duration of each stage will vary among products. Moreover, all products do not go through all the stages. Some products may fail in the introductory stage, and others may not be introduced until the market is in the growth or maturity stage.

The curve showing PLC is typically S-shaped. (also shown above). But all products do not pass through the idealised PLC. The PLC concept should be defined with respect to whether the product is a product class (for example, Cigarettes), a product form (plain filter cigarettes) or a brand (for example Red and White). The PLC concept has a different degree of applicability in these three cases. Product classes have the longest life histories, longer than particular product forms and certainly longer than most brands. Product forms, on the other hand, show the standard PLC histories. Product forms (for example, dial, telephone) seem to pass through a regular history of introduction, rapid growth, maturity, and decline. For brands, a brand's sales history can be erratic because changing competitive strategies can bring substantial ups and downs in sales and market share.

The curve shown above is typically divided into 4 stages. The characteristics of each stage and marketing strategies to be adopted therein (as the PLC concept is useful mainly as a framework for developing effective marketing strategies in different stages of the PLC.) are discussed below :—

### 1. Introduction Stage

The introduction stage starts when the new product is first made available for general purchase in the market place. Prior to introduction, the product had been under the new product development process. Characteristics of introduction stage are :-

- (1) The actual introduction of the product in one or more markets takes time and thus sales growth is slow.
- (2) Another characteristic is that in this stage profits are negative or low because of the low sales and heavy distribution and promotion-expenditure. Promotional expenditures are at the highest ratios to sales because of the great need for a high level of promotional effort in order to inform the potential customers of the new product, induce trial of the product and secure distribution in retail stores.
- (3) The number of competitors is less. They produce basic versions of the products. The firm direct their selling effort to those buyers who are the readiest to buy (usually higher-income groups).

- (4) Price tend to be high due to
- (a) costs are high due to relatively low output rates,
  - (b) technological problems in production may be still there, and
  - (c) high margins are required to support the heavy promotional expenses.

### Marketing Strategies

In launching a new product, marketing management can set a high or low level for each marketing variable such as price, promotion, distribution and product quality. With price and promotion, management can choose one of the four possible strategies shown below.

		Promotion	
		High	Low
Price	High	Rapid— skimming strategy	Slow— skimming strategy
	Low	Rapid— penetration strategy	Slow— penetration strategy

#### Four introductory marketing Strategies

- (1) ***Rapid-Skimming Strategy*** : it means launching the new product with a high price and high promotion. High price is set in order to recover as much gross profit per unit as possible. High promotional expenses are made to convince the market of the product's merits even at the high-price level. The assumptions underlying this strategy are :
- (a) almost the entire potential market is unaware of the product;
  - (b) those who become aware are eager to have it and are capable of payment;
  - (c) the firm faces potential competition and wants to build up brand preference.
- (2) ***Slow-Skimming strategy*** : It implies Launching the new product with a high price and low promotion. (This combination is expected to draw a lot of profit from the market.)  
The assumptions are :—
- (a) the market is relatively limited in size;
  - (b) most of the market is aware of the product;
  - (c) those willing to buy are capable to pay;
  - (d) there is little danger of potential competition.

- (3) ***A rapid-penetration Strategy*** : It consists of launching the product with a low price and heavy promotion. This strategy aims at bringing the fastest rate of market penetration and largest market share for the company. The underlying assumptions are :—
- (a) the market is large in size;
  - (b) the market is relatively unaware of the product;
  - (c) strong potential competition;
  - (d) most buyers want to pay a low price; and
  - (e) the company's unit manufacturing costs fall with the scale of production and experience.
- (4) ***A slow-penetration strategy*** : It consists of launching the new product with a low price and low level of promotion. The purpose is to realise more net profit. The assumptions are :—
- (a) the market is large;
  - (b) the market is highly aware of the product;
  - (c) the buyers want or can afford to pay a low price;
  - (d) there is some potential competition.

## **2. Growth stage**

It is a period of rapid market acceptance and substantial profit improvement. Thus both the sales and profit curves rise at a rapid rate.

### **Characteristics of this stage are :—**

1. The early innovators (buyers) will continue their purchasing and a large number of conventional consumers will begin to follow their lead, especially if there is favourable words of mouth.
2. New competitors enter the market, and in large numbers, if the profit outlook is particularly attractive.
3. The increase in the number of competitors leads to an increase in the number of distribution outlets.
4. Economies of scale are also introduced.
5. Prices either remain where they are or fall only slightly.
6. Promotional expenditures remain at the same or at a slightly raised level to meet competition and continue informing the market.
7. Sales rise much faster thus declining the promotion-sales ratio.
8. Profit margins peak during this stage due to economies of scale.

Marketing strategies to sustain rapid market growth as long as possible :—

1. Improve product quality and add new features and models.
2. Search out new market segments to enter.
3. Finding new distribution channels to gain additional product exposure.
4. Shifting some advertising copy from creating product awareness to trying to bring about product acceptance and purchase.
5. Deciding the right time to lower prices in order to attract price sensitive buyers into the market.

Although by adopting these, the firm will be more competitive but it will have additional cost. The result is that it will capture a dominant position in the market at the cost of forgoing maximum current profit.

### 3. Maturity stage

Maturity is a period of a slowdown in sales growth because the product has achieved acceptance by most of the potential buyers. Profits peak in this period and start to decline because of increased marketing outlays in order to maintain the product's position against competition.

The maturity stage can be divided into three phases :—

- (a) **Growth maturity** : Here, the rate of sales growth starts to decline because of absence of new distribution channels to fill.
- (b) **Stable maturity** : Here, most potential consumers have tried the product and future sales are governed by the rate of population growth and replacement demand. So sales growth rate starts to decline because of market's standstill.
- (c) **Decaying maturity** : The absolute level of sales, here, starts to decline as some of the customers move towards other products and substitutes.

**Characteristics of maturity stage** :—During the first part of this period, sales continue to increase, but at a decreasing rate. While sales are leveling off, the profits of both the manufacturer and the retailers are starting to decline. Marginal producers are forced to drop out of the market. Price competition becomes increasingly severe. The producer assumes a greater share of the total promotional effort in the struggle to retain dealers. Other firms increase their research and development budgets to find new models or better versions of the product.

#### Marketing strategies

A. **Market modification** : Here, the product manager looks for opportunities to find new buyers for the product. There are many possibilities. One is that the manager looks for new markets and market segments in which he has not yet tried the product. Another possibility is that he may look at various ways to stimulate increased usage among present customers (for example, in case of food manufacturers, one way is to list various recipes on their package to increase the consumer's uses of the product. Another possibility may be to consider repositioning the brand to achieve larger brand sales (For example, if heavy users of a chocolate drink mix are found to be mostly older people, the firm may try to reposition the drink in the youth market.

B. **Product modification** : Managers, here, try to increase the sales by initiating changes in the product's characteristics that will attract new users or more usage from current users. Product modifications can take many forms. Some are :—

- (i) **Quality improvement** : This strategy aims at increasing the functional performance of the product (such aspects as its durability, reliability, speed and taste.)
- (ii) **Feature improvement** : Such a strategy has the goal of adding new features which expand the product's versatility, safety, or convenience. For example, the addition of power to hand lawn mowers increased the speed and ease of cutting grass.
- (iii) **Style improvement** : Under this strategy the basic aim is to increase the aesthetic appeal of the product in contrast to its functional appeal. For example, in case of packaged-food and household products, companies introduce colour and texture variations and mostly put great emphasis on package restyling, treating the package as an extension of the product.

C. **Marketing mix modification** : Here, the product manager should consider the possibility of stimulating sales through changing one or more elements of the marketing mix. One possibility is to cut prices in order to attract new triers and competitors' customers. Another possibility is to develop a more effective advertising campaign which attracts consumers' attention and interest or through sales promotion, like, gifts, contests, discounts, etc. The company can also move into higher-volume market channels, specially discount channels, if they are in a growth stage.

#### 4. Decline stage

Decline is the period when sales continue to decline strongly and profits decrease toward the zero point. Most product forms and brands gradually enter a stage of sustained sales decline. The decline may be slow or rapid.

Sales may decline due to technical advances, changes in fashion or tastes or lower costs of imported products. All of these have the effect of increasing over-capacity and price competition or, leading to serious decline in profits.

A company faces a number of tasks and decisions to ensure the effective handling of its aging products. These tasks are

##### A. Identifying the weak products :—

The first task is to establish a system that will identify those products which are in a declining stage. For this purpose, a product-review committee has to be appointed for developing a system for periodically reviewing weak products in the company's mix. This committee include representatives from marketing, manufacturing and the controller's office. The controller's office supplies data for each product showing trends in market size, market share, prices, costs and profits. This information is then run against a computer programme which identifies the most weak products—the criteria being the number of years of sales decline, market-share trends, gross profit margin, and return on investment. After this step, such products are reported to the managers responsible for pushing their sales. The managers fill out their rating forms showing the position of sales and profits with the current marketing programme and with their recommended changes in the current programme. Lastly, the product-review committee examines the product-rating form for each weak product and makes a recommendation (a) to leave it alone, (b) to modify its marketing strategy, or (c) to drop it.

##### (B) Determining marketing strategies

As in the case of declining sales, some firms will withdraw from the market earlier than others, the remaining firms enjoy a temporary increase in sales. Thus any particular firm has to decide as to whether it should be the one to stay in the market until the end. If it decides to stay, it has to choose a strategy. The firm can follow any of 3 strategies :—

- (i) **A continuous strategy** : Under this it continues its past marketing strategy (i.e. same market segments, channels, pricing, and promotion). The product continues to decline until it is dropped at last.
- (ii) **A concentration strategy** : Here the firm concentrates its resources only in the strongest markets and channels.
- (iii) **A harvesting strategy** : Here, the firm reduces its expenses sharply to increase its current profits.

##### (C) The drop decision

When a product has been singled out for elimination, the firm needs some further actions. First, it has to decide whether to sell or transfer the product to someone else or dropping it completely. Second, it has to decide whether the product should be dropped quickly or slowly. Third, it has to decide about the level of parts-inventory and services to be maintained to cover the existing products units.

##### Usefulness of PLC

Its usefulness differs in different decision-making situations as given below :—

- (a) **As a planning tool** : The PLC concept is useful in telling the main characteristics of each stage and indicating the main alternative marketing strategies available to the firm in each stage.



- (b) *As a control tool* : The PLC concept enables the company to roughly estimate the position of its product(s) in relation to successful and comparable products that were launched in the past.
- (c) *As a forecasting tool* : As a forecasting tool PLC concept may be of less usefulness because sales histories show various patterns in practice, and the stages last varying durations.

### **Criticism of PLC**

1. The Life-cycle patterns are too variable.
2. It is difficult to know what stage the product really is in.
3. The company's marketing actions can influence the course of the product life-cycle.
4. PLC concept produces a product-oriented picture rather than a market oriented picture. The reason is that it focuses on what is happening to a particular product rather than on what is happening in the overall market.

### **CONSUMER OR BUYER BEHAVIOUR**

Psychology of modern times plays a role of catalytic agent in the essential knowledge about 'consumer behaviour' and 'Motivation'. The urges or motives stimulate the buyers or consumers to buy. The study of consumer behaviour, embraces as to what are these consumer motives ? What are different motives ? What motives are working in purchasing consumer goods and industrial goods ? The objective in this chapter is to give an analysis of a moderate type of elementary approach. A consumer buys a particular product, because of certain motives. 'Motive' is the strong feeling, urge, instinct, drive, desire, stimulus, thought, emotion, that makes the buyer to react in the form of a decision to buy. Just as every activity of human being has a motive behind, so also is the case with buyers. A person does not buy simply as he is forced but what is required is that of an inner feeling or urge that arouses interest in him to purchase a commodity or enjoy a service at a price. A study of consumer's buying motives, therefore, tells us as to why the consumers have the particular attitudes ? Why they act in a particular way ? Why consumers buy a particular commodity or commodities ?

The number and classification of buying motives differ widely from author to author. For instance, some follow the classification of 'primary' versus 'selective' motives; another group speaks of 'product' versus 'patronage' motives; still another group visualizes as 'emotional' versus 'rational' motives. Again another group comes out which 'acquired' versus 'basic' wants or feelings. It is not our botheration to have a tug of war to prefer a particular classification. However, the classification of 'product versus patronage' motives is more suited and appealing to our discussion, and therefore, this classification is accepted.

Product buying motives are those that are forcing the consumer to incline himself to make some specific purchase because of physical or psychological attraction of the product. The product might be appealing to him as one of the attributes of such a product might be working in his mind. Thus, the design, the colour, size, performance, package, price, dimension, shape of the product may be called as product buying motives. They say, why a particular product alone is preferred to other competitive products. These product buying motives may be either 'emotional' or 'rational'. This sub classification is of much importance, as, there is a wide range of difference between the two words namely, 'emotional' and 'rational'.

Emotional product motives are those where the consumer does not bother much to study plan or apply reasoning while buying or a consumer who is pulsive-quick to accept without much forethought. The consumers are proud of their achievements, social status, standing, activities and gestures. For instance, people buy cars like Plymouth, Cadillac, Alpha-Romeo as they are not worried about its real worth or working, but they are proud of it. A rich family may have "Chippendale" furniture instead of ordinary, even though both the furniture items serve the same purpose.

Imitation is the way of learning the new things easily. It is a human tendency to imitate others, if they are impressed by such behaviour, dress, style of walking, speaking, smoking, etc. Loyalty to a particular personality

may be political, social, or from the world of cinema. Thus, the people started using Rajesh Khanna shirt, and tight pant, his stylish spectacles or goggles, his way of talking and walking. This imitation requires no thinking. Broad ties came to the world, when Dev Anand started using them.

Sex or romance is a psychological and emotional need in case of men and women. It is this 'sex appeal' that makes the teenagers and even adults, to behave in a particular way. It is quite normal that the consumers want to love and to be loved by the members of opposite sex. It is this sex appeal which is so powerful that makes the person more smart or attractive to opposite sex. That is why, men spend much on clothing, cosmetics, entertaining, get-together programmes etc. Ladies do spend on face powders, lipsticks, dresses, scents etc.

Consumers are noted for seeking comforts. That is, they want to avoid strain, pain physical exhaustion, etc. The factors like, softness, accuracy, suitability, noise, space, thirst, hunger, humidity, or temperature affect the concept of comfort. Thus, a rich man is prepared to give higher price for U.M. Foam than a quilt made of coir. He takes soft drinks instead of cold water. An individual of Nagpur is interested in cooling the air, whereas heating it, in Simla.

Man is slave of the habits, it does apply to the ladies also. We cannot say that our habits are a rational. Mostly, they are emotional. People are not rational when they are smoking cigars, beedies or cigarettes or drinking wine of different varieties. Once, such habits are formed, it is difficult to eradicate or change them. However, stronger doses of publicity and salesmanship will bring about a change. Thus, the persons who were consuming edible oil from groundnuts are using Vanaspati or Soyabean oil. As, consumer is a 'social animal', the motive of affection and attachment for others is greater in case of human beings. Thus, a father has affection towards his sons and daughters, a brother for his sisters, husband to his wife. Such an attachment by means of blood relations, forces the members to buy the commodities. Thus, Mr. Henpecked may buy a saree or a necklace made of pearls or diamonds for his wife; a brother may buy a saree for his sister and like wise a father may buy a shirt or a frock for his baby.

Even though, man is a social animal, he is noted for his rationality. He is impulsive. He gives full thought to certain facts, ideas; he analyses the situations well in advance. He is capable of planning, which means creative thinking. There are some buying motives which can be called as 'rational' where emotion has no value nor even a place. Majority of the consumers think much in terms of durability or quality before investing the hard earned money. While buying a piece of cloth, comb, radio, furniture, they enquire and make sure about their durability. This is the concept, based on "higher the price, better is the quality" and better quality goods are durable.

The customers want proper arrangements in their 'sweet home' in terms of the contents of such a home. Customers pay 'much attention to this factor of suitability to have maximum advantage. Thus, a customer, who has small dining hall, will have sizeable dining table that fits well in the room. The capacity of refrigerator differs from individual to individual, depending on the size of one's family and income frequency and purpose of use.

Savings in operation and purchase are normally taken into account, by most of the consumers. Thus an industrial buyer, may buy Kirloskar Oil Engine than that of Imanis, as there is less consumption of oil, it has lesser repair expenses and is easy to handle. For instance, for the Bajaj Scooters buyers pay a heavy price, mainly due to three factors—saving in petrol consumption, high resale value and it is light to handle, as compared to other Scooters in the market. It is common to find that users are prepared to pay high price for a commodity, as they are availing of convenience and ease. For instance, people buy automatic watches, noiseless stoves than stoves of charcoal and wood. Another example, while buying a radio set, the buyer enquires about additional speaker, pickup, tape-recording or even using the set as an amplifier. Life is uncertain, in this world of hazards. Fear is common with every gentleman and lady in one form or the other. One is afraid of his health, another wealth, still another of life. There are many risks that bring about heavy loss to the parties of society. Had there been no fear, precautionary measures would not have been taken. Thus, it acts as a very patent motive to buy the products and services. Thus, vitamin-pills, tonics, iron safe, insurance policies, autolights, burglar alarms are bought and sold. Product motives speak of what product he wants to select. Patronage motives tell about his choice of a particular shop or a store. There are certain factors that force the buyer to buy from a specific dealer.

These may be : location, assortment, personnel, reciprocity, price treatment, concessions extended etc. These patronage buying motives may be either emotional or rational.

Emotional patronage motives are based on the will of a customer. He does not apply his mind or reasoning while patronizing the store or a dealer. The casual factors speak about his selection or behaviour than causal factors. There are quite a good number of customers who are fascinated by appearance of the shop. A well decorated, lighted, colourful store makes the customer to have 'love at first sight'. The alluring appearance makes the customer to get into the shop. This sort of temptations, sometimes, clicks and the purchases are made. Many a times prospective buyers enter the shops, on the recommendation of their friends and relatives, because, the friends and relatives are satisfied with a particular selling house, the customer is likely to get the same advantage.

There are many final users who are mad after imitation. Thus, if Dharmendra is entering Taj Inter-Continental hotel of Bombay, others do enjoy, is not a meal, at least, a cup of tea at a pretty high price. Such activities, on their part, are considered as meaningful events in their life, and they go on quoting these to their friends, as a part of self praise. The people with amassed wealth, high social rank, are worried about their status. Because they want to maintain prestige, they do anything and everything even at a high cost. Thus, some people think it a prestige if they drink Vat-69 only than whisky, rum, or brandy; some people buy only imported things like watches, transistors, clothings, cosmetics etc., irrespective of the cost. They feel that they will be buying these from a particular shop. Entering a specific shop, is also a matter of prestige for them.

For the better knowledge of marketing, it is better to know the buyer behaviour. Buyer behaviour is a comparatively new field of study. It is the attempt to understand and predict human actions in the buying role. It has assumed growing importance under market-oriented or customer-oriented marketing, planning and management. Buyer's market for many products and the growth of consumerism and consumer legislation since 1960 have created special interest in the buyer's behaviour and the formulation of marketing mix to make the buyer respond favourably in the market place. Buyer behaviour is defined as "all psychological, social and physical behaviour of potential customers as they become aware to evaluate, purchase, consume, and tell others about products and services."

Each element of this definition is important as :—

1. Buyer behaviour involves both individual/psychological processes and group/social processes.
2. Buyer behaviour is reflected from awareness right through post-purchase evaluation indicating satisfaction or non-satisfaction, from purchases.
3. Buyer behaviour includes communication, purchasing and consumption behaviour.
4. Consumer behaviour is basically social in nature. Hence, social environment plays an important role in shaping buyer behaviour.
5. Buyer behaviour includes both consumer and industrial buyer behaviour.

Marketing failure or success depends, mostly, on customer's individual and group reactions which is expressed in the form of buying patterns. We have to deal with three main approaches for the buyer behaviour. They are the :

1. Economic model,
2. Psychological model,
3. Socio-cultural model.

Social scientists are proving the question as to why people behave as they do as buyers. The economists' explanation of this is consumer motivation and certain economic factors like, income, its distribution are characteristics of the buyer behaviour. Psychologists found relevance in learning about products and services,

motivations for buying behaviour and products they buy. Sociologists say the influences of group behaviour upon individual behaviour, the diffusion of ideas and new products among various groups and the impact of the culture upon its members, all these influences interact in highly complex ways, affecting the individual's total pattern of behaviour and his buying behaviour.

1. **Economic Model** :—The Economists advanced their explanation to buyer behaviour as they see the market as constituted of homogeneous buyers with same fashion and demand. Man is a rational buyer who knows the market well and uses it to get full value for his buying behaviour. Price is thought of as his strongest motivation. He compares of all sellers offerings and buys the one with the lowest price. He is rational. His buying choices are predictable and yield maximum value. The economic man helps us understand and predict consumers buying behaviour. Decision-making by individuals is very complex. If he wants to buy a certain thing, he will approach several dealers and only in the end make a choice.

**Heterogeneous Markets** : The whole notion of market segmentation is based on the realization that not all buyers are alike, they differ in many ways. Heterogeneity is evident on both the supply and the demand sides of every market. The real marketing problem of the total economy is to match heterogenous segments of supply with heterogeneous segments of demand. Sorting theory regards the entire economic process as starting with conglomerations, moving through various types of sorting and ending with assortments, in replenishing or extending inventories of goods for use by them and their families. This means that the consumer or the buyer enters the market as a problem-solver. Solving a problem, on behalf of either a household or a marketing organisation means reaching a decision in the face of uncertainty. In the double search that prevades marketing the consumer-buyer and the marketing executive are opposite numbers. The consumer-buyer looks for products in order to complete an assortment, while the marketing executive looks for buyers who need his products. This explanation is consistent with those economic theories that explain competition among sellers by emphasizing innovative competition, product differentiation and differential advantage. The position given to every firm engaged in marketing is in some respects unique. Each concern is differentiated from all others by the characteristics of its products, its services, its geomorphic location, survival that is present, to some group of buyers, a differential advantage over other suppliers. Any marketing organisation makes sales to a core market composed of buyers who prefer this source and to a fringe market made up of buyers who find the source acceptable, at least for occassional purchases.

**Income and Personal Consumption Spending** : Many economic factors important to the marketing men, influence consumers in the way they spend their incomes and which are not under the control of individual firms.

To facilitate how people allocate changes in their total incomes between spending and saving, there are two concepts as given by the economists.

1. The marginal propensity to consume.
2. The marginal propensity to save.

The marketing analysts are also interested in examining the effect of changes in income on spending and saving.

Personal consumption spending tends both to rise and fall at a slower rate than does disposable personal income. But at times spending rises faster than income, while during higher incomes, a lower proportion is spent and a higher proportion is saved. In the years of lower income, the proportion spent tends to increase while that saved declines. The concepts of marginal propensity to consume and to save take into account the rates of change, and that is why analysts consider them valuable.

Size of family and family income clearly affect spending and saving patterns but, unfortunately, little research has been reported on these relationships. One study disclosed that in urban families with lower incomes, average personal consumption spending exceeded income. It also showed that the average propensity to consume tended to decline rather rapidly, as income rose above the propensity level.

The next study gave some insights into the spending behaviour relative to household gross income. It confirmed that businessmen had long assumed; average annual household spending rises with increases in gross income per household; those with above average are below average spenders. But contrary to this, the number of people in a household appears, directly, related to the size of its annual income. As the number of people in a household increases, annual household income rises, because more numbers have incomes or people with larger incomes can afford large families. This study also depicted that high income households accounted for a disproportionately high share of total spending. Findings like these are important to the marketing analyst. They imply that significant changes occur in a family's spending and saving pattern as it moves from one income bracket to another. They also indicate that changes in the distribution of all the families, in a population, relative to income brackets, may bring about significant changes in propensities to consume and save.

**Consumers' Income Expectations** : The incomes that consumers hope to get in the future have some bearing on their present spending patterns. Particularly, spending on luxuries tends to be influenced by the consumer's optimism about future income. Thus, consumer's expectations of higher or lower income have a direct effect on spending plans.

**Consumers' Liquid Assets** : User's buying plans are influenced by the liquid assets i.e., cash and other assets easily convertible into cash. Under these come the savings accounts, government bonds, etc. Though, he purchases with ready money; still he is aware of these accounts. Some use it for necessities while others utilize it for medicines etc.

**Consumer Credit** : Through credit facilities he purchases today and pays later. It is not the present income but the purchasing power that influences his credit facilities. This leads to the growth of the markets. Personal debts include all short and intermediate term consumer debt other than regular charge accounts and excludes mortgage and business debt. Personal debt is equivalent to instalment credit i.e. he pays off his debt in various instalments. The size of income is, directly, related to the amount of credit which a consumer can get. Lower income groups can have no debt or smaller debts as compared to high income groups.

**Discretionary Income** : Discretionary income means that which is left over with the user after the expenses on food, clothing, shelter and transportation. This income is utilized in pleasure trips or in the purchase of any other item other than those enumerated above. Consumers are more interested at such times to replace the old things by new ones or get repaired the same with this income. Here also, instalment debt plays its part.

**2. Psychological Model** :—There are mainly three approaches towards the development of psychological theory of human behaviour :

1. Experimental.
2. Clinical.
3. Gestalt or Social.

Experimental psychology deals with physiological tensions or body needs as motivational forces and has experimented with both human beings and animals. In Clinical psychology, basic-physiological drives are examined as modified by social forces. Gestalt or social psychology treats individual and his environment as an indivisible whole and considers individual behaviour as being directed to various aims.

**People's desire of products** : Marketers know consumer behaviour through the related areas of recognition, recall and habitual response. The current trend in psychological thinking is to look at the total experience of the individual and to consider learning as a process in which total functions are changed and rearranged to make them more useful to the individual. Particular external stimuli do not always activate predictable responses as motives and other factors, internal to the individual, also affect responses.



### **Basic factors influencing learning Desire :**

- (a) Repetition is required for the progressive modification of psychological functions and must come with attention, interest and an aim, if it is to be effective. Repetition of situations or stimuli only does not promote learning. So, the advertisers who are bent upon repetition, only waste both their efforts and money.
- (b) Motivation plays an important part in imitating and governing his activities. Activity, in harmony with one's motives, is satisfying and pleasing. Other activity is annoying, when an individual is faced with many motives, it is with learning that he surpasses it. Thus, motivation is helpful to the marketers and helps them to prepare advertising and sales presentations. But marketers and psychologists have not fully understood the basic motives.
- (c) Conditioning—it is a way of learning in which new response to a particular stimulus is developed. The conditioned response establishes a temporary behaviour pattern and at times, it disappears. Research shows that all persons do not respond equally well to conditioning, nor their responses are generally predictable.
- (d) Relationship with organisation—these also facilitate learning. If the thing is presented in a familiar setting, learning effectiveness is increased. Sales messages should relate the products to the consumers' needs and lay the groundwork for buying.
- (e) Retention and forgetting of learned information—retention is the impression left on the buyer. Forgetting is the negative of retention. Messages should be spaced closely enough together to fortify the learning process.

**Buyer behaviour from Clinical Psychology :** It has helped the marketing process. These include unconscious, rationalization, projection and free association.

- (a) **The unconscious:** Freud, a known psychologist suggested that mind contains ideas and urges. Some are conscious, while some are below consciousness but they influence behaviour. People have no knowledge of all these and thereby we come to know that people are ready to buy or not to buy. Practical marketers have long known that there are wide discrepancies between what people say, they will buy and what they really buy.
- (b) **Rationalization:** this tells of the mental processes to find reasons to justify an act or opinion that is really based on other motives or grounds than those stated, though they may or may not be clear to the rationaliser. The prevalence of rationalization explains why did he buy. Rationalisation is a factor in consumer behaviour and to measure it, indirect research approaches like depth interviewing are used.
- (c) **Projection:** This is concerned with the reactions that occur when a person seeing someone else facing a certain situation, or problem, assumes the other person's reactions would be the same as his own. He ascribes his motives to the other person. Motivation researchers have designed projective techniques that give a means for uncovering consumer's unconscious motives and attitudes.
- (d) **Free Association:** This is through psychologists. "The basic idea is that if a person gives up the equal logical controls he exercises over his thoughts and says whatever comes into his mind at the moment in the presence of a skilled listener, unconscious feelings and thoughts can be discovered" as put by Newman in his "Motivation Research and Marketing".

3. **Socio-cultural model :** Psychological tests show that human activity and buying behaviour are directed towards the satisfaction of certain basic needs. Every person does not act in the alike manner. They are modified by the individual's particular environmental and social background. The motivation comes from the tensions made to satisfy the basic needs, that come within consciousness. The action taken by the person reduces these tensions. Clinical psychologists have not agreed to a single list of basic needs. The different lists dictate more

agreement than dis-agreement. Basic needs are according to the importance, first importance is solved and then other is tried. Maslow has described each category of needs in the following way :

1. **Physiological Needs:** This means to satisfy hunger, thirst, sleep. These are the most basic needs. They have first priority, other needs have no importance.
2. **Safety Needs:** These needs consist of economic and social security while physical security is not much needed.
3. **Belongingness and Love Needs:** The affectionate relations with individuals and social place is of much importance. If these are not fulfilled it gives place to maladjustments.
4. **Esteem Needs:** Persons crave for self-honour and a high place is given for esteem needs. Their fulfilment leads to self-confidence and usefulness. If these are not afforded, there is a feeling of inferiority and helplessness.
5. **Need for Self Actualization:** It is to get the maximum of one's capabilities. This is present in every person, its fulfilment depends more on prior fulfilment of basic needs.
6. **Desire to know and Understand:** This means the process of searching for a meaning in the things around us.
7. **Aesthetic Needs:** The need for beauty is strong among those who have fulfilled the basic needs.

External or inter-personal influences on buyer behaviour are :

- (a) Family Factors
- (b) Reference Group Factors
- (c) Social Class Factors
- (d) Cultural Factors

(A) **Family Factors** : Most consumers belong to a family group. The family can exert considerable influence in shaping the pattern of consumption and indicating the decision-making roles. Personal values, attitudes and buying habits have been shaped by family influences. You can notice the brands used by a new housewife in her kitchen are similar to those favoured by her mother. The members of the family play different roles such as influencer, decider, purchaser and user in the buying process. The housewife may act as a mediator/gatekeeper of products that satisfy wants and desires of the children. Marketer is interested in four questions relating to family purchases :

1. Who influences buying ?
2. Who does the family buying ?
3. Who takes the buying decision ?
4. Who uses the product ?

There may be four different people or only one member of the family may do all four activities. For most products, the housewife in Western countries is the main buying agent for provisions and grocery articles. Marketing policies regarding product, promotion and channels of distribution are influenced by the family members making actual purchases. If teenagers and children are decision-makers, marketing programmes will provide special attraction like premium with the products. Advertising appeal will be determined by the men, women or children acting as the real decision-makers in family purchases. Family life cycle also influences consumer expenditure patterns. In the development of a family, we have several important stages—marriage, birth of a child, maturation of children, married children leaving home, older couple with no children living at home and so on. For example, the proportion of a family's budget spent on food and clothing will generally increase when children arrive in a newly wed family. On food items, influence of housewife is always dominating. On luxury items both husband and wife can exert joint influence.



(B) **Reference Group Factors** : The concept of reference group factor is borrowed from sociology and psychology. The buyer's behaviour is influenced by the small groups to which the buyer belongs. Reference groups are the social, economic, or professional groups and a buyer uses to evaluate his or her opinions and beliefs. Buyer can get advice or guidance in his or her own thoughts and actions from such small groups. Reference group is a useful self-evaluation and attitude formation group. A human being is considered as a social animal, spending much of his or her life income in group factor situations. Consumers accept information provided by their peer groups on the quality of a product, on its performance, style, etc., which is hard to evaluate objectively. Group norms or standards direct attention of its members to a new style or a product. They provide a frame of reference which is the first stage in the consumer decision-making process. Group influence is seen in brand choices. A family in a circle of friends, a local club, an athletic team, college living groups, are examples of small reference groups in which members have face- to-face interactions. Words-of-mouth communication is the process by which messages are passed on within a group from member to member. It is often a critical factor in determining who buys what product and of what brand. Group members provide relevant and additional information which cannot be provided by mass-media. A satisfied customer becomes the salesman of the product. Oral advertisement by satisfied customers can influence the prospective buyers in the buying process. The group leader acts also as an opinion leader regarding certain products. A person may have several reference groups for various subjects. He may prefer a particular brand of cigarettes, tea, coffee, etc., because his respective reference group prefers that particular brand of the product. Opinion leaders can act as effective agencies of communication on behalf of the marketing management. Marketing efforts may be directed to provide such opinion leaders.

(C) **Social Class Factors** : Sociology points out the relationship between social class and consumption patterns. As a predictor of consumption patterns, marketing management is familiar with social classes. Consumer's buying behaviour is determined by the social class to which they belong or to which they aspire, rather than by their income alone. Broadly speaking, we have three distinct social classes—upper, middle and lower classes. Consumers belonging to middle classes usually stress rationality, exhibit greater sense of choice-making, whereas consumers of lower classes have essentially non-rational purchases and show limited sense of choice-making.

The three social classes will have differences in the stores they patronise, the magazines they read and clothing and furniture they select. Social classes may act as one criterion for market segmentation. T.V. usage by different social classes was investigated in the U.S.A. and it showed that working class embraced television, the lower-middle class accommodated it, and the upper middle-class actually protested it in 1962 survey in Chicago. Upper class consumers want products and brands that are clear symbols of their social status. Middle class consumers shop carefully and read advertisements and compare prices before they buy. They are highly amenable to pre-selling through mass-media. Lower class consumers buy usually on impulse and should be influenced by point of purchase materials. They do not care to read much. Hence, the broadcast media like radio are of great importance in communicating with them.

(D) **Cultural Factors** : Culture represents an overall social heritage, a distinctive form of environmental adaptation by a whole society of people. It includes a set of learned beliefs, values, attitudes, morals, customs, habits and forms of behaviour that are shared by a society and transmitted from generation to generation within that society. Please note that culture is alive, moving and ever-changing. It reacts to internal and external pressures causing inter-cultural conflicts. Cultural influence is a force shaping both the patterns of consumption and patterns of decision-making from infancy. Much of our behaviour is determined by culture. Our cultural institutions like family, schools, temple, language, customs, traditions, etc. provide guidelines to marketers. Technological advances may influence cultural changes. Education and travel can have considerable influence on culture. Marketing strategies can be developed for each culture separately. Market segmentation can be based on culture as one determinant. Sub-cultures exist within the dominant culture as one of the determinants. Sub-cultures exist with the dominant culture with its own set values, beliefs, attitude, habits and behaviour patterns. In Indian culture, we have some important bases of sub-culture such as cast, region, religion. Thus, the patterns of behaviour would vary between north and south India, Brahmins and Vaishyas, Muslims and Jains.

\*\*\*\*\*

## LESSON 2

---

# FINANCIAL MANAGEMENT

---

Finance is the life blood of any business. Business may be big or small, finance is needed, the only difference is the amount of finance required. Small sized business is invariably financed out of the personal savings of the businessman. But after the industrial revolution the size and complexities of business increased tremendously, making impossible for a sole trader or partnership firms to finance such large sized ventures. Joint stock companies filled this gap and made possible to collect huge funds from a large number of persons and that too with their liability limited. “The joint stock company form has proved a flexible and valuable instrument. It joins the venturesome and the countious, the wealthy and the penniless, the capable and unskillful, the energetic young and retiring old into a system of contractual relationships which make it possible for each to make the most appropriate part in those gigantic business enterprises which stretch across the continents and overseas<sup>1</sup>.” In our study of financial planning, we shall primarily refer to the financial planning of joint stock companies because this form of business organisation dominates the industrial world.

Business finance simply means the provision of money when it is required. In the present money-oriented economy, we simply cannot imagine any business without money. It has been rightly remarked by someone that money is needed to earn money but in order to earn money, the money invested must be well managed. That is why Wheeler defined business finances as that activity which is concerned with the acquisition of capital funds in meeting the financial needs and overall objectives of the business enterprise<sup>2</sup>.

### Finance Function

Finance function is a separate functional area of management like production, marketing, personnel etc. No doubt, production and marketing are the basic sub-systems of a business system but finance sub-system is of strategic importance because their success depends directly upon the efficient operation of finance sub-system. Finance function is so closely inter-related with the other sub-systems of a business system that it is almost impossible to segregate it from the general business management. In fact, so closely are the financial matters of a business system associated with the plans and results of every other department that in a sense, every proposal and every decision involving financial problems has a bearing on financial results. It is precisely due to the ever increasing importance of finance function in the business that the role of the finance manager is undergoing a constant change and the scope of finance function has broadened beyond recognition.

Earlier finance function was concerned with procurement of funds, hence all the earlier studies were confined to sources of raising finance and the institutions involved in raising finance. Finance was defined by Paish as the provision of money at the time it is wanted. Now it is well recognised that procurement of funds, though an important aspect, covers, only a part of the finance function. The other important aspect is the wise-use of funds procured for business.

---

1. Guthmann and Dougale : Corporate Finance Policy.  
2. Wheeler : Business : An Introductory Analysis.

The primary objective of any business is to earn sufficient profit to pay a reasonable return to the investors and also to retain a part of the profit for ploughing back into the business. So the scope of finance function not only covers the task of fund procurement but also the most suitable allocation of funds so as to maximise the profits. In the words of Guthmann and Dougale. “Business finance can broadly be defined as the activity concerned with the planning, raising, controlling and administering of funds used in the business”.

### **Objectives of the Finance Sub-system**

The objectives of finance section should be so tailored that they fully match the overall objectives of the business system. It has to maintain a balance between liquidity of funds and profitability. The objectives of financial management can be summarised as under :

- (1) To procure adequate supply of capital for the business when needed;
- (2) To conserve and increase the funds invested through sound management policies;
- (3) To ensure a reasonable rate of return to the suppliers of capital;
- (4) To ensure the best utilisation of capital to generate income; and
- (5) To coordinate the functioning of finance department with the other departments of business.

In order to achieve these objectives it is expected of a financial manager to take the following decisions:

- (a) **Financial planning** : He has to prepare budgets of various financial requirements in order to avoid the possibility of excess or shortage of funds. The funds to be collected have to be prudently invested so that the return is maximised without endangering the solvency of the company. In short he is responsible for investment decisions.
- (b) **Financing decisions** : Finance manager has to decide a suitable capital structure or financing mix of owned funds and borrowed funds : short term and long term debts.
- (c) **Management of cash** : He should see that sufficient supply of cash is always available to business. For ensuring this, cash flow statements are prepared from time to time.
- (d) **Dividend decision** : Finance manager has to decide how much profit should be retained for ploughing back into the business and how much should be distributed among shareholders.
- (e) **Financial controls** : Finance manager can measure the performance through appropriate measures like cost control, break even point analysis and ratio analysis. It can keep additional check by internal audit programmes, budgetary control etc.

### **Finance Organisation**

Finance department is always organised on functional lines. Though it is normally regarded as a separate functional area, yet it is closely knit with the general business management. Every proposal, every decision, directly or indirectly comes in the fold of financial decisions. Prof. Soloman rightly remarked that financial management is an integral part of the overall management rather than merely a staff activity concerned with the fund raising activity.

Organisation of finance department on functional lines highlights the importance of this basic activity and provides the scope for the appointment of experts in the field of financial management and also provides

an opportunity for the training of personnel in the area of management. The idea of organisational structure of finance department can be made clear by the following organisational chart :

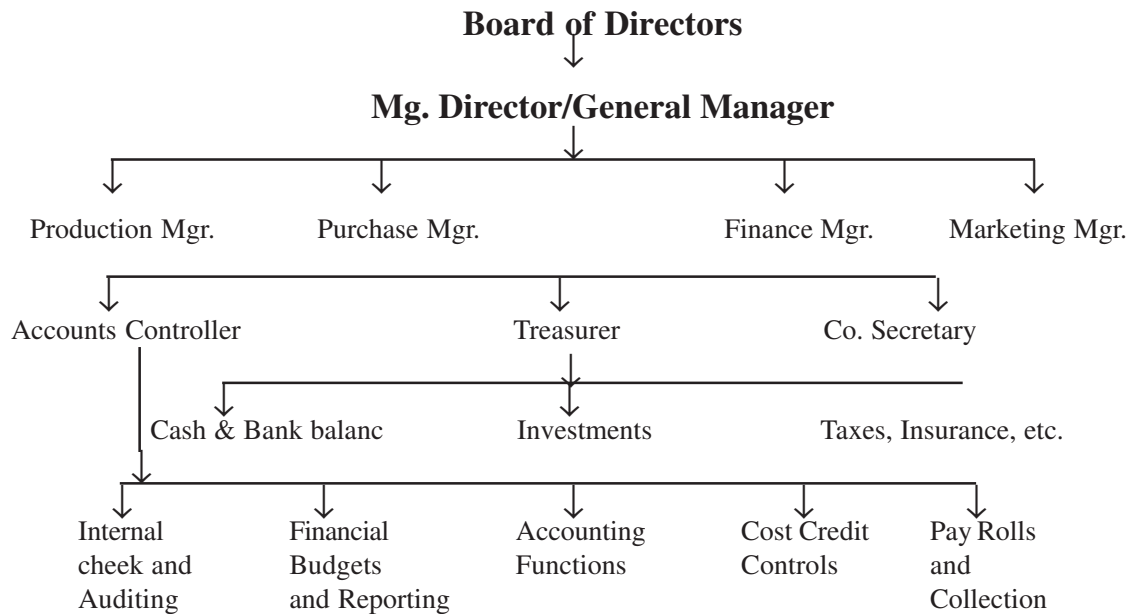

The organisational structure of finance department differs from company to company depending upon their size, conventions followed, capability of the man at the helm of affairs and the policy followed by the top management. For instance, in some companies, a company secretary may be looking after all taxation and financial reporting jobs; in others there may be a treasurer to perform the function of cash and bank balance management while in others these functions may be performed by the Assistant Finance Manager. But in all organisational charts, one thing is common and that is the presence of one controller who may be called as Finance Controller or manager or director or by any other name who has to see that the expenditure is done within the financial policies laid down by the board of directors. He is responsible for co-ordinating the financial policies and procedures with the rest of the organisation.

## Financial Planning

Planning is deciding in advance what is to be done. It is a projected course of action. Financial planning is a vital part of overall planning of any business. A finance manager has to see that the funds needed are made available from most appropriate source in the required amounts, at the appropriate time and at a cost that will make their use in business profitable. Financial planning pertains to the determination of financial objectives, financial policies and financial procedures. As far as the overall objective of the company is concerned, it may be one of the several objectives but the finance manager has to keep the profit maximisation as an operative objective in his day to day activities and operations and thus maximisation of the total wealth of shareholders. In order to achieve this objective, financial resources have to be properly managed with a systematic planning and control. Financial planning is necessary both for new as well as existing firms. In fact, the process of financial planning begins from the day the idea of forming a company is conceived by the promoters. The task of financial planning is undertaken by the promoters before the formation of a company and after that it rests with the top management. Any mistake in the financial planning in the initial stages is likely to create serious implications afterwards. If a company is incorporated with inadequate capital, it may not be able to meet its commitments and its very existence may be endangered. If on the other hand more capital is collected than warranted in terms of the amount of capitalisation, it may reduce the rate of earning at the same time pose the problem of management of surplus funds.

Financial planning aims at solving following three basic problems :

- (i) What is the total amount of capital required for the business ? —Capitalisation
- (ii) a. What are the different sources from which funds are to be collected ? —Capital structure  
b. What will be the proportion of different types of securities ? —Capital Gearing.
- (iii) What is the suitable time for raising capital from a particular security and other financial policies ? —Capital Administration.

### **Principles of Financial Planning**

While formulating the financial plans, the following principles should be kept in mind by the financial planners :

1. **Objective** : All financial planners should always move with one basic principle while formulating financial plans that their job is to procure capital at the lowest possible cost and make the best possible use of funds thus collected. Their objective must be in line with the overall objective of the company. For example, if the policy of management is to promote sales at any cost which may be giving liberal credit facilities, naturally, the financial planner has to make arrangement for working capital and at the same time make provision for bad debts.

2. **Simplicity** : As far as possible the simplicity principle should be adhered-to while drafting plans. The capital structure should not be unnecessarily stuffed with a number of securities. A simple plan is easy to understand and easy to implement.

3. **Flexibility** : Business is full of uncertainties. So a financial plan must be capable of being adjusted according to these changes. Even in the initial stages, promoters must make provision for contingencies and inflationary pressures. A financial plan should be such that it has scope for raising additional funds at short notice. There should be such a degree of flexibility so that it could be adopted with minimum delay to meet the changing conditions.

4. **Liquidity** : Adequate cash, bank balances and easily convertible securities should exist in sufficient amount to ensure liquidity. The term liquidity, in our context, means the availability of cash to make payments, whenever so required. But, where, in order to ensure liquidity, funds are kept idle, profitability is bound to be affected. So, the planners must make a judicious balance between liquidity and profitability. But at no cost, liquidity should be sacrificed for the sake of profitability because this tendency endangers the safety of the company. Adequate liquidity enables the company to meet its commitments in time and face the uncertainties of future.

5. **Planning foresight** : Good planning needs intelligent imagination. Capital plans should take care of changes in demand, supply conditions, trends in capital market and so on. At the same time the plan should be capable of taking care of future expansion.

6. **Economy** : Planners must provide the desired capital at the lowest possible cost of collecting funds. The interest bearing securities should be used only after considering the rate of return, otherwise the obligation of fixed payments may erode into company's rate of return and cause over capitalisation.

7. **Control** : The plans are to be governed by the degree of control the promoters wish to retain over the company. If they wish to maintain control over the company, naturally they have to rely more on fixed interest bearing securities because the fixed interest bearing security holders do not enjoy voting rights.

8. **Optimum use of fund** : Mere adequacy of capital is not sufficient, its proper use is equally important. While taking decisions about the funds to be collected, the planners should continuously bear in mind, the

purpose to which these are to be put. Financial plans should be so drafted that the funds once collected do not remain idle or used for unproductive purposes.

9. **Self-generated growth** : A financial plan should be such that it makes the company least dependable on outsiders. It should ensure sufficient return on investment so that it could be saved and ploughed back into the business year after year for the growth and expansion of the company.

### **Financial Planning in India**

The basic principles of financial planning hold good every where, yet the capital plans drawn differ from country to country because of the difference in economic conditions prevailing in those countries. Capital plans formulated in our country are governed by various Acts, like Securities Contracts (Regulation) Act, Capital Issues Control Act, etc. The existence of Specialised finance institutions and institutional investors make marked difference. To what extent the promoters propose to have assistance from these specialised finance institutions or what is the attitude of the institutional investors towards a particular company greatly affect the ultimate plan. The amount of capital to be collected is further affected by the fact whether the company is getting any subsidy under the Central and State subsidy scheme.

After considering all the above mentioned factors, the promoters of a company prepare a financial plan in the form of a capital investment budget. It is based on the estimates of expenditure on various items and the contributions to be had from :

(1) Indian promoters, (2) Foreign collaborators, if any; (3) Public issue, (4) Specialised financial institutions and (5) Availability of any subsidy from the government.

In order to have clear understanding of financial planning of a new company, let us take a concrete illustration of the capital plan drawn for a recently promoted chemical company.

### **COST OF THE PROJECT**

The cost of the project is estimated at Rs. 1,89,00,000 as under :

	(Rs. in Lakhs)
1. Land	9.87
2. Building	16.50
3. Plant and Machinery	55.00
4. Misc. Fixed Assets	44.27
5. Technical know-how fees	13.00
6. Preliminary and Pre-operative Expenses including share issue expenses	21.65
7. Contingencies	14.50
8. Margin money for working capital	<u>14.10</u>
	Total <u>188.89</u>
	Say <u>189.00</u>

## MEANS OF FINANCING

It is proposed to finance the above cost of the project as under :

(Rs. in Lakhs)

1.	Issue of Equity Capital		
	(a) Promoters, Collaborators, Directors and their friends	22	
	(b) Public Issue	33	55.00
2.	Rupee Loan From:		
	(a) ICICI Bank	24	
	(b) GIIC	60	114.00
	(c) GSFC	30	
3.	Central and State Subsidies		20.00
			<u>189.00</u>

If we scan the above finance plan, we find that the plan contains the essentials of a sound capital plan. Adequate provision has been made for contingencies, and working capital. The plan is simple, it comprises only two types of securities—equity capital and long term loan from specialised financial institutions. The plant being located in a notified backward area has also obtained a Central and State subsidy of Rs. 20 lakhs.

The promoters and their collaborators have contributed hardly 11 per cent of the total cost of the project. General public has contributed 17 per cent of the cost of the project. Equity issued to the public is 60 per cent of the total equity capital issued, hence the shares can be quoted on a stock exchange because it fulfills the provisions of Securities Contract (Regulation) Act. At the same time, promoters can safely expect to retain their grip over the affairs of the company.

### Estimating Financial Requirements

After becoming sure of the commercial feasibility of the project, the promoter has to proceed to make estimates for the total capital needs of the company. In this exercise of total capital requirement calculations, the two most important underlying factors are the nature of business and size of business. These two factors have to be remembered at every step in making capital calculations. The total capital requirement estimation should include the present needs and also provision for future developments. The total capital requirements have further to be estimated from the point of view of foreign currency. This type of analysis is very significant, especially in a country like ours where sophisticated machinery and technology has to be imported.

There are two approaches for estimating the total requirements. The first is to make detailed item-wise estimates and total them up. This is called the *Estimation Method*. The other method is the *Comparison Method*. According to this method—calculations are made on the basis of estimates of some other companies of the same type and same size. In this method the promoters have to make adjustments for price level changes.

The following items enter into the calculation of total capital estimates :

- (1) **Promotion expenses** : incorporation fee, consultancy fee and other preliminary expenses.
- (2) **Cost of fixed assets** : Land and building, tools, machinery, equipment, furniture and fixture, miscellaneous fixed assets.



- (3) **Working capital** : Normal cash balances advisable to be kept in hand; inventories and funds to be tied in debtors and miscellaneous current assets.
- (4) **Cost of financing** : brokerage and commission.
- (5) **Cost of establishing the business** : operating losses other than depreciation, up to the time when the business will be financially self-sustaining.
- (6) **Cost of intangible assets** : patents and goodwill.
- (7) In addition to all these, some provision for contingencies.

The estimates for each of these figures should be supported by detailed schedules carefully and skilfully compiled. The importance of the various items varies among different types of business. A personal service business has little or no fixed property or inventory. Merchandising concerns may need only minor amounts for furniture and fixtures. Fixed investment is likely to be more important for the manufacturer, partly because of his greater investment in equipment and partly because of his greater difficulty in securing efficient housing except by constructing a building adapted to the particular needs of the enterprise. Fixed assets are particularly important for heavy industries like steel, fertilisers etc., and often a large percentage represents the total assets. Financial companies cannot really be said to have financial requirements in the same sense as other businesses. The bulk of the assets of such a concern, however, are its investments, which are in proportion to the volume of business with customers and deposits with the commercial bank.

From the above discussion, it is clear that every business enterprise will require capital broadly for the following three purposes :

- (i) to finance fixed assets.
- (ii) to finance working capital or current assets needs.
- (iii) to finance improvements and extensions.

A brief description of these needs is given below :

### **Fixed capital**

Fixed capital consists of land, buildings, plant, machinery, fixtures or any other property that is permanently committed to the business. (Example for the last item is the regular working capital). These assets are not fixed in the sense of their value but fixed in the sense that they are committed to the business for a long period of time and difficult to be converted into cash in a short period. Fixed capital is usually highly specialised and if the business does not earn the minimum required rate of profits, these assets cannot be disposed of except at a loss. The fixed asset is needed to carry on the profitable operations over a long period of time.

However, the cost of fixed assets varies from concern to concern depending upon (i) nature of business, (ii) type of manufacturing (simple process or complicated round-about process) (iii) the size of business unit, and (iv) the mode of acquiring the fixed assets. As regards the nature of business activities, marketing enterprises require a small amount of fixed capital as compared to industrial concerns in general. Public utilities and capital goods industry require much greater amount of fixed capital than what is needed in consumers<sup>5</sup> goods industries. Enterprises like railways, tramways, or electricity companies have to be started at their full size in the very beginning, and hence the cost of fixed assets becomes comparatively larger. On the other hand most of the consumer goods industries can be started on a modest scale and expended gradually for reaching their full growth. The size of the business is an obvious determinant of the amount of fixed capital.

As regards the mode of acquiring assets they can be purchased outright or on the basis of instalment payments. Particularly valuable machines can be acquired on instalment basis. Some other assets like land and building can be acquired in many cases on the basis of lease agreements. Moreover, in many concerns tools and equipments are manufactured by the companies themselves for meeting their own requirements. These different considerations will affect the amount of fixed capital.

To be on a safe side and prevent possible interruption in the flow of business operations, fixed capital needs must be properly assessed and financed. These needs must be financed from permanent sources of finance such as issue of shares, debentures and long term investments. If fixed capital needs are financed with short term finance, it may interrupt the business activities and the rate of return because short term debts fall due very soon and possibly the firm might be running short of funds at that time. Obviously, failure on the part of the management may lead banks to stop granting or renewing credit facilities to the firm.

## **Working Capital**

Working capital is necessary for holding some convertible assets like stock of materials and finished goods, bills receivables, accounts receivables and cash. Through the use of these assets the operation or the working of the business is carried on. These assets rotate around the business activities in a circular way and are fed again and again but in a circular flow. There is a definite cycle about which these assets move. For example, materials are processed or transformed into finished goods which are sold to the customers on credit for creating bills receivables or accounts receivables, and such bills or accounts receivables are liquidated into cash that can again be utilised in purchasing materials for production purposes. But working capital does not represent the amount invested in these assets. The group name of these assets is current assets. Corresponding to these assets, there is a group of current liabilities comprised of bills payables, accounts payables, expenses payable etc. Working capital is the excess of current assets over current liabilities.

The amount required for current assets should not be confused with the working capital. Some writers have used the term circulating capital or revolving capital for it. This is because the working capital is invested, recovered, and reinvested repeatedly during the life time of the concern. In other words, it keeps on revolving or circulating from cash to current assets and back. Apparently, it would appear that working capital requirements can be met with short term funds but this is not so. Some of its part is permanent in nature and so we must make a distinction between temporary and permanent or regular working capital requirements.

At the time of the commencement of business, permanent investment is needed not only in fixed assets but also in current assets to make production feasible and this part of initial working capital is permanently blocked in the enterprise. Amount of working capital needed over and above this level is temporary working capital. With the passage of time, size of the temporary and permanent working capital changes.

## **Importance of Adequate Working Capital**

Adequate working capital is one of the pre-requisites for the business to be continued. Business performance is bound to come down and even to a halt, in the absence of adequate working capital, no matter how much the concern has invested in fixed assets. The importance of adequate working capital lies in the following :

- (i) In the first place sufficient funds are necessary for purchasing the materials, and meeting day to day expenses in the form of salary, wages, rent and so many others.
- (ii) Secondly, payment to sundry creditors is to be made in time for the maintenance of reputation and credit standing of any company. Moreover, prompt payments result in cash discounts.
- (iii) Thirdly, advances from the banks are conditioned by the availability of sufficient liquid assets.
- (iv) Fourthly, for the payment of dividends in cash to the shareholders, funds are necessary.

All these considerations show the importance of adequate amount of working capital needed by any business concern to run the operations of the business uninterruptedly and smoothly.

## **Determinants of Working Capital**

The working capital needs are not uniform for all the enterprise and therefore, facts responsible for a particular size of current assets in one concern are different from the other enterprise. Therefore, a set pattern of

factors determining the size of working capital is difficult to suggest. However, following are some of the most important factors determining the size of the working capital in an enterprise:

### **1. Nature of Business and Length of Operating Cycle**

A close relationship exists between the nature of the business and the length of the operating cycle, in so much so, the length of the operating cycle is a function of the nature of business. For a vertically integrated manufacturing firm the operating cycle consists of converting cash into raw materials, raw materials into finished goods, selling the product or products through its retailing outlets, and converting the accounts receivables into cash. For an independent retail trade store, the manufacturing portion of the operating cycle is eliminated but the conversion of inventories into receivables, and then into cash remain. For providing those services, the inventory problem is usually eliminated but the collection of receivables remains. Firms selling services on a strictly cash basis may be able to disregard working capital altogether, while cash and carry retail trade outlets eliminate the need to finance receivables.

Where *cost of raw materials* to be used in manufacturing is very large in proportion to total cost, working capital requirements are bound to be large. For instance, in sugar and, textile mills, raw materials are of prime importance, hence more working capital needed.

The amount of working capital is also affected by the *technique of production*. In labour intensive industry larger working capital is required than in a highly mechanised one. The latter will have a larger proportion of fixed capital.

### **2. Management Attitude Towards Risks**

It is generally accepted in principle that greater the risk a management is prepared to undertake, greater shall be the opportunity for profit or loss to increase. In the area of working capital, management risk implies operating with a lesser amount of current assets than are indicated, by a given level of the firm's operational activity. Thus, if the management decides to operate with a lesser amount of working capital in relation to its level of production, it is carrying greater risk and there is a greater opportunity for its profit or loss to increase. A mere progressive management may opt for greater risk by keeping its investment very near the optimum level and thus increase the chance of a higher rate of return on their investments.

### **3. Turn Over**

By turn over is meant the ratio of annual gross sales to average working assets. It is this figure which shows how many times the amount invested in working assets has been treated in or turned over during a year. It must be remembered that the relation is between gross sales and working assets and not between gross sales and working capital. The higher the turn-over the lower the period for which goods remain in the inventories. If sales are quick, there will not be much stock held up in the inventories. But if the sales are not regular and are uncertain, then the inventory will be in the stock and the amount needed for this will be heavy.

### **4. Terms of Purchase and Sales**

If an enterprise is paying in cash for everything it is purchasing, and selling it on credit, it will obviously need a working capital sufficient to purchase outright its entire stock of goods including everything that has been sold but not yet paid for. On the other hand, if the enterprise is able to buy on long credit and sell for cash, it can provide for its whole stock with no immediate outlay and will pay its bills as they mature out of the receipts from its own sales. But in ordinary course of time neither of these extreme arrangements prevails. Goods are both bought and sold, atleast in part, on credit basis although the recent tendency is to reduce the length of the credit period. The longer the period for credit, the larger will be the working capital needed to finance the transaction.

## 5. Cash Requirements

The greater the cash requirements, higher will be the amount of working capital. If a company has sufficient amount of current assets which can be easily converted into cash or has good banking connections it will not need large cash balances.

## 6. Seasonal Requirements

Seasonal industries like sugar, woollen mills etc. have to buy raw materials in a particular season as their sales are made largely in that season. So, their working capital requirements are more during that season in which they have to buy raw materials for manufacturing.

It would be impracticable to attempt to draw up any formula for calculating the amount of working capital required in any given concern. We must content ourselves with the general statement that working capital requirements vary roughly in proportion to the volume of business, the length of period of manufacture, and the average length of the credit extended to customers, and the extent of seasonal variation in volume of business. These vary roughly inversely to the rapidity of turn-over, length of the credit obtained in purchase of goods and the facilities available for converting current assets into cash. These are the factors to be taken into account. Since the customary units of time used in reckoning most commercial operations is the month, it is worthwhile to make estimates of the working capital requirements on a month to month basis.

## THE CAPITAL STRUCTURE

Earlier it was shown that every type of business organisation needs finances for its operations and for its growth. The finance that it needs consists of various types, e.g., long term, medium term and short term and there are different sources or channels through which such financial needs are satisfied. This latter aspect shall be discussed in greater detail in the next chapter. Another way of looking at the problem of finance is to *see the form in which the total financial requirements are met* That is how much should be *owned funds and how much borrowed funds*. Broadly speaking the composition of liabilities side of the balance sheet is called the capital structure. According to Gerstenberg, 'capital structure' refers to the make-up of capitalisation. Capital structure involves the selection of securities and the determination of their proportionate amount. In fact, there is no such thing as the capital structure which may be regarded as the most appropriate either for all sorts of companies or even for the same company for all times.

According to the prospects of earnings, the capital structure of companies should be devised with different securities in such a way that it would become *safe as well as economical*. The general principles that guide the issues of three different types of securities, viz., debentures, preference shares and equity shares, may be stated as follows : (a) debentures should be issued by a concern that is expected to have a stable and sufficient income to pay the fixed interest charges; (b) preference shares being normally cumulative in nature can be issued when the average earnings are fairly good, though annual earnings may be of uncertain character and (c) when there is no certainty of income, equity shares should be issued. But these general principles do not help much in determining the actual proportion of different securities in the capital structure. In fact, every company is required to issue all the three types of securities and not a particular type alone that is suggested by the general principles.

The part played by long term debt, preference shares, equity shares and retained earnings depends upon several diverse factors. It is the job of the skilled financial manager *first* to recognise such factors and *then* to balance or compromise these factors in order to design the capital structure of the company under consideration. The problem of deciding the proportion of various kinds of securities is the problem of *Capital Gearing*. Capital gearing means the decision about the ratio of different types of securities to total capitalisation. That part of capitalisation on which fixed interest or dividend is to be paid shows gearing. Capital gearing is also called as Leverage and is the ratio between the borrowed funds (fixed return securities such as debentures

preference shares, loans etc.) and the ownership securities (equity shares and reserves and surpluses not distributed to shareholders but belonging to them). Capital structure of a company is said to be ‘highly geared’ when the proportion of fixed charge bearing securities is relatively more than the ownership funds.

On the other hand, a company is low geared when it raises its capital primarily by the issue of equity shares.

It is the job of the skilled financial manager to have a judicious mixture of different types of securities in the make up of capitalisation because the capital structure suitable for one company may not be suitable for another company. Gold Smith has suggested certain basic principles which must be met by every company in deciding its capital make up. Those basic principles are :

- (A) The method of financing must have the *power of resistance*. It should be able to face the periods of loss or the gestation period. Undue dependence on fixed interest securities may endanger the very existence of a company, if it does not have regular earnings.
- (B) While financing, future should not be sacrificed at the cost of present. The Scheme of financing *should not be a hindrance* to the fullest development of the enterprise.
- (C) The over-all *cost of raising capital* should be kept minimum.
- (D) The capital structure chosen should be *simple* because a simple scheme is easy to manage and avoids unnecessary suspicion in the minds of those who fail to understand the complexities of capital structure.

The aforesaid considerations are not complementary but competitive and usually contradictory. In practice, a company has to use different types of securities so, it is ‘gearing’ that requires great skill and experience in deciding the capital structure. Guthmann & Dougall have divided the factors affecting capital gearing into two parts. He terms them as conditioning factors—Internal factors and External factors. Internal factors can well be in the control of the management but external factors are normally out of control of a company, for example, capital market sentiments. In order to have an ideal capital structure these two factors must be judiciously reconciled. The various factors grouped under ‘Internal’ and ‘External’ groups are given below :

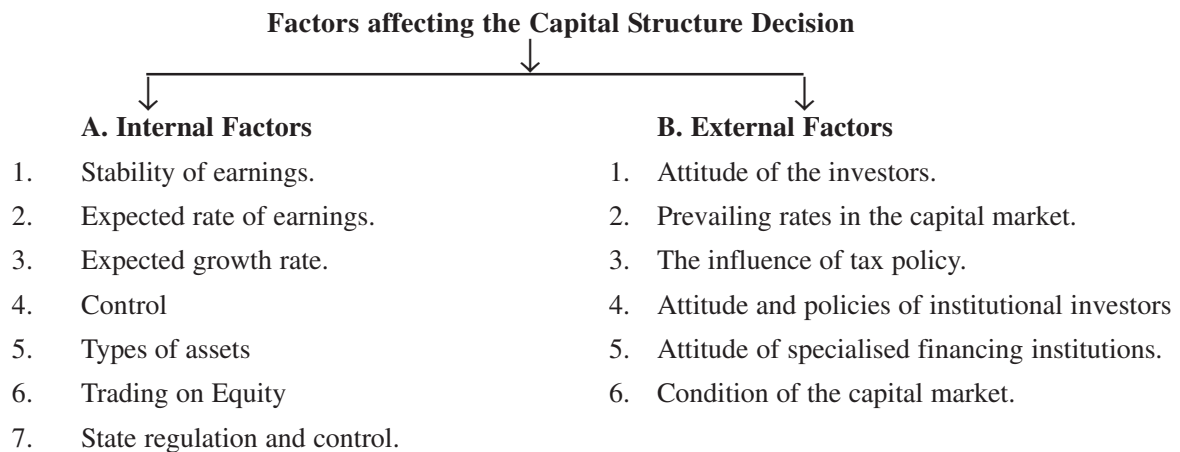

### (A) INTERNAL FACTORS

#### 1. Stability of Earnings

Probably the most important internal factor which influences financial structure decision is the stability or certainty of expected earnings. The use of debt implies that earnings are sufficiently predictable to enable the business to meet its obligations, but because the future is uncertain, opinions may differ as to how much debt is appropriate. Hence, one has to find out whether the expected earnings will be stable or unstable.

Instability of earnings may arise either due to changes in the volume of the business or due to the inability to maintain satisfactory relation between selling price and expenses. In the matter of volume, the weakness may lie either in the industry as a whole or within the individual firm. Unstable earnings (whatever their cause may be) make the use of debt dangerous and less attractive to investor desiring regular and stable income. Companies subject to this risk should avoid debentures, keep preference shares at a minimum and favour equity shares and retained earnings as sources of funds. Companies that are some-what sheltered, from volume instability by monopoly or partial monopoly, enjoy a greater freedom in their choice of methods of financing. But earnings' instability may also arise from fluctuations of the profit margin. This potential hazard may result from recurrent price wars, danger from an unusually heavy burden of fixed costs, or inadequate rates.

Ordinarily, the past record of stability of earning is regarded as a sufficient index of ability to bear a burden of fixed interest charge safely. Sometimes, however, it is necessary to consider the factor of predictability. Thus, a small business with a record of stable earnings might, because of its peculiar dependence upon the abilities of a *single person*, have an unpredictable future. Small business, therefore, generally lack appeal for long-term investment by outsiders. Paradoxically, this limitation puts such business under the necessity of relying, to a greater extent, upon the short term credits which have a risk for the business, but permit continuous supervision and check-up by the bankers, and hence it lessens his risk. Typically, small concerns have low ratios of long-term debt to total assets but have relatively large proportions of short-term borrowings.

## **2. Expected Rate of Earnings**

The lower the return earned by a business, the more difficult it will be to finance any considerable growth out of the earnings. A business that is earning little but expects a high return in the future has a special incentive to finance with a prior security, either through preference shares or debentures or long term loans, with the expectation of retiring them from subsequent earnings or refinancing with equity shares at a more favourable time. But this is possible only when management finds that investors are ready to appreciate and understand its (management) enthusiastic appraisal of the future and the company can sell the shares at a price that reflects the growing future rather than the gloomy present.

## **3. Expected Growth Rate**

Securities are sold when growth is expected at a rate more rapid than can be financed by retained earnings. The choice of security is determined by the temperament of the management and the comparative costs of debt and equity shares. But, in general, fast growing companies with great need for funds are more likely to use debentures or preference shares. In such situations, management hopes to profit from trading on equity and to be able to repay such obligations from the profits generated out of expansion. If such expectations are realised then the existing equity shareholders gain from the expanded earning power that has not been shared with new cash drain paying interest and repaying principal that such prior securities require.

## **4. Control**

The desire to retain the voting control of the companies in the hands of a particular group may also influence the form of financing. The use of debentures or long term loans avoids the sharing of control with others. After a company has reached a certain size, however, the issue of additional shares having voting rights may actually strengthen the hold of the controlling group upon a corporation by making the total equity larger and the cost of buying a controlling interest much greater. Small shareholders, widely scattered, usually ignore their proxies or deliver them to the existing management, at least so long as the corporation is moderately successful. Thus, the desire to retain managerial control in its own hands, the existing management may influence its form of financing.



## 5. Typs of Assets

Some argue that the nature of assets influence financing. Such people associate large fixed assets with long-term debt and large current assets with short-term debt. In fact, this is not a correct fact and a right way of looking at the problem. It is generally advisable that a part of financial requirements for current assets is met by long-term sources. The reason being safety and uninterrupted working of business. It is a different thing whether such long-term financing will consist of debentures or loans or equity. Financing through debentures or loans will depend on the stability of the probable earnings rather than the probable life of the assets concerned. In other words long physical life does not ensure either stable capital value or a steady income flow suitable for long-term financing of the fixed charges.

## 6. Trading on Equity

When a company raises its capital by the issue of equity shares as well as by borrowed funds and preference shares, it is said to be trading on equity. Simply speaking, by the term trading on equity is meant, taking benefit with equity. This benefit is availed of by equity shareholders at the expense of other form of fixed income securities. It is the arrangement under which an enterprise uses borrowed funds, carrying a fixed rate of interest, in such a way that it increases the rate of return on the equity shares.

Suppose a company needs a capital of Rs 2,00,000 to earn 30,000 every year. If it collects its entire funds by issuing equity shares, the rate of dividend will be 15% per annum. If, instead, it decides to trade on equity and collects its funds in the following manner :

(a)	by Issue of 10% Debentures of	Rs. 50,000
(b)	by raising 12% loan from Financial Inst.	Rs. 20,000
(c)	by Issue of 11% Preference shares of	Rs. 80,000
(d)	by issuing Equity shares of	

Now the company has to pay :

(a)	Interest on 10% Debentures	Rs. 5,000
(b)	Interest on Loan	Rs. 2,400
(c)	Dividend on Prefrance shares	Rs. 5,500
	Fixed payments to be paid	Rs. 12,900

The balance Rs. 17,100 ( 30,000 – 12,900) is available for equity shareholders and their rate of dividend will rise to 21.4%  $\left( \frac{17,00 \times 100}{80,00} \right)$ . Thus, they have gained 6.4% just by trading on equity.

This benefit they have obtained at the cost of fixed income securities, i.e., by using their funds and making them fixed payments. Besides, interest on loans is a deluctable expense and thus it will cause savings on the payment of income tax. Trading on equity has its own limitations which are given below :

- Rate of earning must be more than the rate of fixed payments to be made. As in our example in order to gain by trading on equity the rate of interest must be less than 15%.
- The company must have sufficient assets that can be offered as security to the lenders.
- Company should be sure of regular earnings. There should be minimum fluctuations, if it is to trade on equity. Too much dependence on borrowed funds may pose serious problem during lean periods.



- (d) Lastly, there is one inherent limitation in trading on equity. More the company borrows, higher is the rate of interest, and lesser is the benefit to shareholders.

## **7. Purpose of Financing**

Where funds are required for betterment, these should be raised through shares or through retained earnings because betterment expenses invariably do not increase the earning capacity. But when money is needed for productive purpose, it may be raised through borrowings.

## **8. Period of Financing**

Long term funds are raised only through equity shares or debentures or preference shares. Short term needs are met by borrowings and funds needed for 10 years or so may be raised through redeemable preference shares.

## **9. Elasticity**

The capital structure should be elastic enough to provide scope for future expansion. Too much dependence on fixed interest securities makes it rigid. In the initial stage debentures should be avoided.

# **(B) EXTERNAL FACTORS**

In the preceding paragraphs, we have examined the various factors which influence the pattern of financing i.e., the capital structure of the company. Besides these factors, however, there are other factors which are also considered while designing the capital structure of the company concerned. These factors are outside the control of that company and/or the industry, and hence, these factors have been grouped as external factors.

## **1. Attitude of the Investors**

This is a very important factor which one has to take into account while determining the form of financing. Possibility of savings habits and experience give rise to investment attitudes. These attitudes become so rigid that many a times management does not like to deviate from these conventional norms, though circumstances may reasonably permit such deviations. We also find that some of the attitudes are like fashions which undergo quick changes and such changes are not based on logic or reason. But the fact remains that such attitudes which represent such current whims, should be taken into account while formulating the financial structure of a company.

## **2. Prevailing Rates in the Capital Market**

The form and the timing of corporate financing are also influenced by the prevailing rates paid for capital in the securities market. The rate which the individual corporation must pay is determined by several factors such as the general level of interest rates that are prevailing at the time of the financing, the market's appraisal of the credit standing of the corporation, and the proposed form of financing. The form of financing, in turn, is determined by a comparison of the costs of the various alternatives, a consideration of the risk to the corporation, and its availability in each form. Thus, debt financing may be chosen because of its cheapness, and its availability in spite of the risk that it may lead to. That is, the danger of cash insolvency leading to legal bankruptcy. The small corporation may choose short-term debt because it is cheaper or because it is the only credit obtainable, although the continuous problem of renewal or repayment may require more efforts and it may be a potential threat to solvency.

## **3. The Influence of Tax Policy**

Tax policies prevailing in the country also influence the form of financing. For example, it is well-known that company taxation in most of the countries is at a pretty high level which has put a premium on debt financing as compared to money from preference shares or through equity shares. Therefore, the popularity for debt financing

arise from the fact that the interest payable on debt is a deductible item in the profit and loss account for tax purposes while dividends are not chargeable in the income statement. This is one of the powerful factors which has created imbalances in the capital structures of many companies in India. Even the specialised financial institutions have changed the traditional norms of debt-equity ratios.

#### **4. Attitude and Policies of Institutional Investors**

In most of the capital markets of the world today, there is more and more institutionalisation of savings. This has resulted in the growth of large number of institutions like life insurance companies, investment trusts, unit trusts, commercial and savings banks etc., which exert dominant and powerful influence on the working of the securities markets. These institutions have to follow a particular type of investment policy either under a specific law which governs their functioning or by the conventions based on the particular nature of their work. For example, Life Insurance Corporation of India always prefer long-term securities with steady return. These institutions control a large segment of the total demand for securities and hence it is quite obvious that the company managers will have to take this factor into account while formulating the form of financing.

#### **5. Attitude of Specialised Financing Institutions**

In most of the countries special financing institutions are today exerting a very powerful influence in the financial markets of that country. This is true-for our country also. Today in our country these special financial institutions are playing such an important role that there can hardly be a company which has not received large financial assistance from these financial institutions in one form or the other. This point is relevant for us because these institutions are guided by certain policies and they follow certain norms and hence the borrowing companies have to fulfil these norms in order to get finance from these institutions.

#### **6. Conditions of the Capital Market**

While determining the form of financing, the financial manager of a company cannot ignore the conditions prevailing in the capital market of his country. For example, if the capital market is in the buoyant condition it is easy to raise even large money through equity share but is not so easy to do when the capital market is in the dull and depressed condition. In the latter situation, debt financing may be easier. Hence, the financial manager has to read the pulse of the capital market.

#### **7. State Regulation and Control**

In some countries the governments prescribe or lay-down certain guidelines or regulations regarding the raising of capital from the market in different forms. For example, in India, the Capital issues Control Act lays down specific-norms for debt-equity ratios and hence, the manager has to take note of such factors in finalising the financial plans of his company. For example, a banking company can issue only equity shares.

### **CAPITALISATION**

The term capitalisation has been defined by different writers in different ways in different contexts and one finds as many definitions as there are writers on this subject. Authors like Husband & Dockeray give a broad interpretation to the term and regard the term '*capitalisation*' and '*financial planning*' as one and the same thing. According to them the term '*capitalisation*' is exhaustive in its scope and includes not only the determination of amount of capital (quantity aspect) but it also includes the decision regarding type of securities (quality aspect).

The narrow interpretation of the term includes only the quantitative aspect. Even in the narrow sense different authors have attempted to define it in different ways but now the meaning of the term capitalisation is generally understood that '*Capitalisation comprises of a corporation 's ownership and borrowings as represented by its long term indebtedness*'.

So, capitalisation may be said to be the sum of :

1. The face value of shares of different kinds.
2. The face value of debentures and bonds not yet redeemed.
3. Long term debts.
4. Surpluses not meant for distribution—whether capital-surplus or revenue-surplus.

The term 'Capitalisation' is different from the term 'share capital' and 'capital' and it can be used only in relation to a joint stock company because it is only a joint stock company which can issue debentures and bonds. The term share capital means only the face value of paid up shares and the term 'Capital' includes all loans and surpluses but 'Capitalisation' includes only long term loans and surpluses not meant for distribution in addition to share capital.

To solve the problem of determining the amount of capitalisation is necessary both for a newly started enterprise as well as for an established concern. There are two theories of determining the amount of capitalisation, namely, the Cost Theory and the earnings Theory.

### **The Cost Theory**

In this theory the amount of capitalisation is determined from the summation of a number of capital expenditures required for putting the company as a going concern. In simple words, under the cost theory of capitalisation, a company's value, worth, or capitalisation is worked out by aggregating the cost of fixed assets, the amount of regular working capital required to run the business, the cost of establishing the business and other costs such as promotion and organisation expenses and to cover possible initial losses.

For example, if investment in fixed assets, current assets, and other items is made to the tune of Rs. 20 lacs, Rs. 5 lacs and Rs. 2 lacs respectively, the total amount of capitalisation would be Rs. 27 lacs. Amount of capitalisation calculated under the cost theory facilitates the calculation of the amount to be raised.

But this approach although simple to understand and calculate suffers from certain deficiencies, the main being that there is no provision for contingencies provided for future. Or if some assets lie idle, or are poorly employed, will result in low earning and the company will not be able to pay a fair return on capital invested. The result will be over-capitalisation.

In order to do away with these difficulties and arrive at a proper rate of capitalisation, earnings approach is used.

### **The Earnings Theory**

Under the earnings theory of capitalisation, two factors are generally taken into account to determine the capitalisation :

- (a) What is the expected volume of earnings.
- (b) The prevailing rate of return.

For example, if 10% be the rate of return and Rs. one thousand be the expected earnings of a business, the amount of capitalisation would come to Rs. ten thousand in terms of earnings theory. As the earnings theory is based upon two factors—the fair rate of return and the probable future earnings, any mistake in calculation in respect of these two factors would lead to the adoption of wrong amount of capitalisation.

Moreover, the earnings theory is based upon the 'rate' by which the earnings are to be capitalised. But this rate is difficult to estimate as it is determined by so many factors. But even then it provides a sound basis of capitalisation.

## OVER-CAPITALISATION AND UNDERCAPITALISATION

Over capitalisation arises in those cases where the company's earnings are too low to give a fair return on shares and debentures issued by the company, i.e. the company is not earning adequate return on the assets employed. It is so because the assets employed exceed the actual requirements of the business. For example, if the actual amount of assets needed is Rs. 2,00,000, the rate is 10%. But if company raises Rs. 2,40,000. The concern will be over capitalised to the extent of Rs. 40,000. If the earnings are Rs. 20,000, the rate of return available to equity shareholders will be 8-1/3%. So the company would be said to be overcapitalised because the rate of return is less than the required rate of return. Overcapitalisation should not be taken as excess of capital. In fact, there may be overcapitalised companies having shortage of funds.

The overcapitalisation appears from the overvaluation of assets in relation to the amount of shares and debentures issued by a company. That is the amount of securities exceeds the value of the assets. Such overvaluation may be caused by a number of factors like:

- (i) The enterprise may raise money by issue of shares and debentures than it can probably use.
- (ii) If the company borrows a large sum of money and has to pay a rate of interest higher than its earnings.
- (iii) When higher amount of goodwill has been paid to the vendor from whom the asset has been purchased.
- (iv) The company might have acquired the assets in the boom period when the price of the assets were at the peak. But now they may have fallen to a considerable extent.
- (v) The company might have not provided for adequate amount of depreciation and thus having high earnings, so distributing high rate of dividend in the initial period but after some time the company may find it difficult to pay adequate amount of dividend as the actual value of the asset may have been much lower than as shown in the books.
- (vi) High rates of taxation may leave little in the hands of the company to pay adequate rate of return to the shareholders.

Due to this over-capitalisation, the company may find itself in certain difficulties like:

- (i) The price of its shares in the stock market decline due to lower rate of dividend and higher rate of interest in the market.
- (ii) The company may lose its credit-worthiness and hence the company may be required to pay a higher rate of interest to the suppliers of funds.
- (iii) Moreover, it will be difficult for the company to raise capital in the market.
- (iv) The lower rate of return may induce the company to raise the price of its product if it is operating on monopoly terms in order to have higher margin of profit to pay adequate rate of return.

### Remedies for Over Capitalisation

The problem of over capitalisation poses certain problems for a company as well as to the shareholders whose wealth in terms of share market value has gone down. To overcome these problems and difficulties certain measures and steps are to be taken, some of which may be listed as follows :

- (i) Reduction of interest on debentures which increases the earnings available to shareholders and thus raising the rate of return.
- (ii) Reduction in the number of preference shares.
- (iii) Reduction of par value of shares.

- (iv) Reduction in the number of equity shares so that the dividend per share may be increased.
- (v) Complete reorganisation of the concern in terms of financial needs, sources and allied matters.

So, overcapitalisation is very harmful for the company as well as for the shareholders and for removing this difficulty, the whole thing has to be reorganised.

### **Under-Capitalisation**

Under-capitalisation is the reverse of overcapitalisation. It may refer to either the situation where the market value of assets is in excess of the book value of the assets shown in the books of accounts of the company or the company might be earning more rate of return as compared to other norms and paying a higher rate of dividend to its shareholders. In a large well established concern there may be a very large appreciation in the value of assets especially of plant, goodwill and the buildings. This appreciation may not be brought in the books. So under-estimating the value of assets in the books whereas the actual market value is much more than this. In such cases the dividends will be much higher and the market quotation for shares will also be higher than warranted by the book value of the assets.

So, a company is said to be under-capitalised when its actual capitalisation is less than its proper capitalisation as warranted by its earning capacity.

The different causes of under capitalisation are just reverse to those responsible for over-capitalisation, namely:

- (i) Under-estimation of earnings.
- (ii) Capitalising earnings at a higher rate.
- (iii) Conservative dividend policy.
- (iv) Maintenance of high efficiency.
- (v) Increase in price level and so on.

But this under-capitalisation although good for shareholders is detrimental to the company in the long run. The main consequences of under-capitalisation may be as follows:

- (i) Competition is encouraged by the higher earnings of such companies.
- (ii) High dividend rates give an opportunity for workers to ask for increase in wages.
- (iii) It may give the consumers a feeling that they are being exploited by the company.
- (iv) It may limit the marketability of the shares and thus narrow the market of the shares of the company.

These consequences in the long run will reduce the profit margin of the company and make it equivalent to the earnings of the other similar companies. But to remove this problem, following steps may be taken :

- (i) Splitting-up of shares.
- (ii) Increase in par value of shares.
- (iii) Issue of Bonus Shares.
- (iv) Re-appraisal of assets upward.

One thing should be noted here that sometimes over-capitalisation and under-capitalisation are misunderstood in terms of abundance of capital and shortage of capital, respectively. But in fact this is not so.

## COMPARISON BETWEEN OVER-CAPITALISATION AND UNDERCAPITALISATION

The comparison between over-capitalisation and under-capitalisation is difficult to make. Over-capitalisation is a most common feature of the enterprises whereas the under capitalisation is a rare occurrence. Still, if we compare their respective pros and cons we can conclude that under-capitalisation is a lesser evil. Under-capitalisation is more beneficial not only for the shareholders but also for the society and the economy in so far as it brings stability in the society, increased prosperity to the nation and high rate of earnings and increased prices to its shareholders. Besides, the non-existence of these advantages to an over-capitalised firm, as seen earlier also, demands as a remedy, a high cost in the form of sacrificing a part of their interest in the corporation or by bringing more doses of capital in the enterprise because of a great drain on the financial structure of the company.

Thus to make a logical comparison, the question to be asked would be, which one is better— over-capitalisation or under-capitalisation? But which is the lesser evil? The above details suggest that over-capitalisation should be discouraged and a fair capitalisation be the attempt of every company.

## SOURCES OF FINANCE

The term ‘source’ implies the agencies from which capital is procured in the business world. For two types of capital, viz., fixed and working, different sources are tapped by business enterprises. Fixed capital involving long-term financing is primarily available from two sources— buyers of securities and lenders of long-term funds. Working capital, on the other hand, involving partly long-term financing and partly short-term financing, can be procured from the suppliers of fixed capital as well as from the lenders of short-term funds. That is to say, the sale of securities and the borrowings of one kind or another are the principal means of securing capital on the part of business concerns.

Before going into the details of these sources, the ways in which the money is actually raised, the various considerations in selecting a source of finance, the finance manager should have a working knowledge of the mechanism of financial market as is operating in his country.

Financial market, as the name suggests, consists of various institutions, intermediaries and the instruments which are needed for the provision of loanable funds from those who have these to those who need or seek. For convenience sake, financial market is subdivided into two major groups—the long term funds market: called as ‘*Capital Market*’ and the short-term funds market called as ‘*Money Market*’. In actual practice, it is very difficult to classify finance market in such water-tight compartments as Capital Market and Money Market. In fact, there is lot of overlapping between the two and many a times we notice the participant of one market is visible in other market. Both these together are integral parts of one composite financial market.

These words ‘Capital Market’ and ‘Money Market’ have been deliberately mentioned here to make the reader aware of the fact that the sources of supply of funds and their significance— whether in long, medium or short term funds depend largely on the nature of financial mechanism that a country has. If it has developed one, we find the different relative roles of the different sources, where as in an underdeveloped financial market, the seekers of funds have to orient their financial strategy in different ways.

## RAISING OF FINANCE

Raising of finance is effected by different means depending upon the forms of business, the types of capital needed, the nature of financial market (developed, underdeveloped or undeveloped) as well as upon the size of the business. Basically, finance for business comes from ownership funds and borrowed funds. Ownership funds are supplied in the case of unincorporated enterprises in the form of direct contributions by proprietors and partners. In corporate enterprises, ownership funds are supplied by the buyers of shares. Borrowed funds are supplied by a number of lending agencies (individuals and institutions).



Important sources for raising finance under varying circumstances are indicated below :

**Fixed Capital for large-sized enterprises** : (1) sale of securities, (2) foreign investments, (3) public deposits from the investing public, (4) term loans from finance and development corporations, (5) retained profits in the case of existing enterprises, and (6) State assistance in special cases.

**Working Capital for large-sized enterprises** : (1) commercial banks, (2) sale of securities, (3) retained profits, (4) private deposits, and (5) public deposits.

**Capital for small enterprises** : (1) ownership funds, (2) State Finance/Development corporations, (3) private deposits from friends and relatives, (4) commercial banks, (5) indigenous bankers and money lenders, (6) co-operative banks, and (7) state assistance in different forms.

From the above list of sources of capital accumulations, it is apparent that many agencies supply funds for meeting both working capital and fixed capital requirements. These agencies can be divided into two parts - (a) Ordinary financial institutions such as insurance companies, banks and investment institutions, (b) Specialised institutions or Development banks. Of these different sources of supplying finance, State Finance and Development Corporations have been dealt with separately.

## Shares

Shares represent equal portions into which the capital of a company is divided, each shareholder being entitled to a portion of the company's profit corresponding to the number of shares he has in his name.

A company can issue two types of shares namely equity shares and preference shares. Equity shares or the common stock is regarded as the corner stone of the financial structure. Both for legal and economic reasons, a company organised for profit can't exist without equity shares in so far as they do not carry with them any fixed commitment charges. If a company is earning large profits, the shareholders get a higher amount as dividend and if somehow the profits of the company come down then in that case the equity shareholders will get lesser amount for their investment. The fact that company does not have to pay any fixed return on the equity shares is one of the main advantages of using this method of raising finance. It is in fact the first type of security to be issued by the corporations and the last to retire in the event of liquidation, so it occupies primary and residual position respectively in the two situations. As has been said earlier, one must note that the earnings of the equity shareholders vary according to the earnings of the company. So it is said that any change in the business brings corresponding changes in the fortunes of the equity shareholders. Because of this position equity capital is said to be the venture capital or risk capital of the company and it is provided by the ordinary or equity shareholders.

The main feature of the common stock is that it provides a way of raising cash for the company with no fixed commitment charge attached to it.

From the investor point of view, equity share-holding gives the shareholder an opportunity to share in the profits when declared as dividends, an opportunity to make money on appreciation in the value of shares and opportunity to vote for the directors of the company.

However, equity shares, as a method of providing funds, are not free from certain problems which can be stated as :

- (i) The issue of large proportion of equity shares results in the dilution of control by the clique of the equity holders.
- (ii) Use of more equity share capital deprives right from trading on equity which results in losing opportunity of using cheap borrowed capital.
- (iii) Excessive use of equity may result in overcapitalisation.
- (iv) It is having an attraction only for those who can not take risk.



## **Preference Share Capital**

Preference share capital can be defined as that part of the share capital of the company which fulfils both the following requirements, namely that it carries preferential rights in respect of dividend and also that it carries preferential rights in regard to repayment of capital in case of winding up. The dividend on these shares is fixed. The company may be a prosperous one but the preference shareholders get a fixed rate of dividend.

It is a hybrid form of financing, in the sense that it combines the features of debt and equity, i.e, it carries a fixed rate of dividend which is similar to return on debentures but it does not have a prior charge for payment like debentures. This latter feature is similar to equity shares in terms of return on capital. In the event of liquidation, a preferred stock holder's claim comes after that of company creditors but before that of an equity shareholder. Usually this claim is restricted to the face value of the Shares.

These shares can be divided into different types such as participating, redeemable categories like cumulative and non-cumulative preference shares. Participating preference shares have a right to something above their fixed dividend. Redeemable preference shares can also be issued but they must be fully paid up.

These preference shares, although have priority above the equity shareholders but they have a restricted voting power. Preference shareholders can vote only on resolutions directly affecting their rights. The management issues preference share capital because the affairs of the company remain fully in the hands of the present management. From the investors' point of view, the preference shares are safer than the equity share-holdings. But in terms of cost, these preference shares cost more in the sense that the dividend paid to the preference holders is not a deductible expense whereas the interest paid on loans is a deductible item to calculate the tax liability.

## **Debentures**

The other common method to raise finance by a company is through loans. The loans of long term character can be raised either through transferable security or through negotiated loans. Debentures belong to the former category. It is a transferable security under which the company acknowledges the receipt of money and for a specific period of time (redeemable variety) or for an infinite period of time (irredeemable variety). The document is known as debenture. Debenture-holders are the creditors of the company and get a fixed rate of interest on the stipulated dates. Generally these debentures are secured. The advantage to the company in raising money through debentures lies in the fact that the interest payable on such debentures is a deductible item in the profit and loss account and therefore the profitable company enjoys the tax benefit (known as tax-shield). This, therefore, helps in the reduction of cost of finance to the company. The other important gain to the company is that the debenture-holders being the creditors to the company are not entitled to participate in the management of the company. Hence, the management at times likes to retain control by issuing debentures. Debenture-holders also (conservative type) prefer the investment of funds in this variety of debentures because it ensures a steady income and prior claim in the event of company's winding up. One thing we should note is that the debentures are commonly regarded as safe securities but the investors have to depend more on the financial soundness and the profitability of the venture rather than the mere legal protection offered by the debenture security.

Debentures have been an important source of financing everywhere but in India they have not been so popular in the past. Recently, however there has been a marginal change in this regard on account of the depressed capital market as well as the special interest shown by special financing institutions like the Unit Trust of India and the Life Insurance Corporation of India. The unpopularity of debentures is generally regarded on account of the following factors. Some of them are felt by the issuing company and some of them faced by the investors.

**Difficulties of the Issuing Company**—(i) Because of the high stamp duty, the cost of raising capital in the form of debentures becomes very high, (ii) Companies hesitate to issue debentures which may dry up the bank credit for their inability to offer clean and unencumbered security to bankers.

**Difficulties of the Investors**—(i) Debentures are usually issued in denominations of Rs. 500 each and as such common investors cannot purchase debentures (ii) Debentures are not issued with attractive terms; service of trustees for debenture-holders are not generally available, and the securities market cannot ensure a prompt liquidity of debentures, and (iii) As debentures are purchased by conservative investors, the Government securities are more preferred than debentures by those investors. Besides the safety of investment, the Government securities are being offered at present with an attractive yield factor. As a result there is a general diversion of funds towards saving certificates, plan certificates etc.

In order to make debentures attractive now the companies have introduced convertible clause. These convertible debentures have become very popular with investors.

### **3. Public Deposits**

Under this method, the company invites the public to deposit their money with the company for a specific period at a specified rate of interest. In India, on account of certain historical reasons, this method was very popular till the first quarter of the present century. At that time, the public themselves used to run to good companies to deposit their surplus funds. This was the most important source for the cotton mills in Bombay and Ahmedabad. The system however, had its own drawbacks and weaknesses. In times of real need of money it was difficult to obtain deposits through this source. The tendency of the depositors to withdraw their advances on the slightest rumours made the position still worst. This system therefore is highly inelastic, volatile and very undependable.

At present no facility is available of 'insurance cover' as it is available for bank deposits. The interest received by investors is not free from income tax. The funds thus collected from public may be used in non-priority sectors and the indiscriminate borrowings may distort interest rate pattern in the country. The maximum rate of interest payable is now 8% and on debentures it is 7.5%.

The sluggishness in the capital market after 1962 and the increasing difficulties experienced by the company in raising finance again attracted the investors for making public deposits. The difference was that the company now invites the public to deposit their funds with the company. During the last two decades or so there has been a substantial growth in public deposits. But unfortunately several cases of malpractices were noticed. Hence, the Reserve Bank of India issued several rules and regulations for the acceptance of the deposits by the Non-Banking and Non-Financial Companies. The purpose is to curb the undesirable and unhealthy practices of the companies and thus to protect the interests of the innocent investors.

### **4. Retained Earnings**

Ploughing back of profits is a method of financing, commonly used by the established companies. It is an internal source of finance. It is a part of profit which has not been distributed to shareholders in the form of dividends. This method avoids any long-term commitment and does not dilute the ownership by sale of voting shares. As far as expansion programmes are concerned, the retained earnings provide a better method as there is no immediate pressure on the company to pay back the amount. The method of ploughing back of profits is cheaper.

The method of ploughing back or self-financing has its shortcomings and if carried too far, might prove dangerous. In the hands of over zealous directors it might lead to overinvestment in the industry causing over expansion. Again the shareholders who have little individual interest in the company and who are ever-changing, want as high a dividend as possible. If in pursuit of a policy of building up reserves, the directors, though unwillingly, lead the shareholders to believe that they are inconsiderate to the interests of the latter, there is a

great danger of the available capital being distributed in an ill-balanced manner, so far as the industry is concerned. But one thing should be noted that if such a policy is pursued cautiously, this method can help, to a great extent, to grow.

## **5. Loans from Specialised Financing Institutions**

Today, perhaps there will be no company of worth naming which has not received financial assistance in one form or the other from the special financial institutions operating in India. It is only after independence that the Indian government took special steps to promote, establish and help the creation of those special financing institutions. The Industrial Finance Corporation of India (IFCI) was established in 1948 and since then dozens of large and or small financing corporations have been created. The Industrial Development Bank of India (IDBI), started in 1964, is the apex body to co-ordinate the activities of all the financial institutions operating in the country. These institutions with minor variations provide financial assistance in the following forms :

- (a) Provision of loans (long-term);
- (b) Underwriting of shares and debentures issued by the companies;
- (c) Guaranteeing loans and deferred payments etc. on behalf of the companies;
- (d) Direct subscriptions to shares and debentures of the companies; and
- (e) Re-financing of loans, (this is specially done by the IDBI).

Since the details of their working etc., has been discussed in the subsequent chapter it is enough to note here that these institutions which were created initially to supplement the existing channels in a way to help the main sources have now become so essential that they have become the part of the financial system of the country.

The borrowing company has to submit a detailed application form for obtaining loans and other financial assistance from these corporations. They have also to submit a copy of the project report to the financial institutions so that the later can make a thorough appraisal of the borrowers' financial position as well as the profitability of the proposed plan.

However, with the entry of commercial banks in the long-term financing of business, these financial institutions are disappearing one after the other. Some of these have even converted or started as Banking Companies. IFCI has disapproved, IDBI, ICICI, HDFC have started and merged with banking units. UTI has also started a UTI Bank.

## **6. Other Financial Institutions**

In this category, we can include the commercial banks, the Unit Trust of India and the Life Insurance Corporation of India. Commercial Banks are conventionally regarded as the main source for short term finance but recently they have been participating in medium term loans also. The borrowing companies procure finance from commercial banks in a number of ways.

Unit Trust of India and the Life Insurance Corporation of India fall under a different category. Unlike commercial banks, they do not give direct financial assistance to the companies but provide help in indirect manner by underwriting shares and debentures of the company and directly subscribing to their securities. In most of the States in India, the State governments have also sponsored development corporations to provide financial and other help to the companies.

The above sources of finance are for long term and medium term. Long term funds are raised for a minimum period of ten years & medium term funds are raised for a period ranging from more than one year to

less than ten years. Finance can be raised for short term also. Its period is twelve months or less than this. Short term finance can be raised from the following sources :

1. **Trade Credit** :—Trade credit facilitates the purchase of supplies without immediate payment. It is a very simple method of raising short term finance. No interest is payable on trade credits. The actual cost is the loss of cash discounts. Moreover, no charge is created against the assets of the buyer of goods. Trade credit is given to reputed customers only. The period of credit depends upon the nature of the product, location of the customer, customs of trade, degree of competition, etc.
2. **Instalment Credit** :—This type of credit is given by the equipment suppliers to business firms. Some portion of the cost price of the asset is paid at the time of delivery and the balance is paid in a number of instalments. Interest is also included in the amount of instalment.
3. **Accounts Receivables** :—Under this source, the accounts receivables of a business concern are purchased by a financing company. The finance companies usually make advances upto sixty percent of the value of the accounts receivable pledged. Bad debts, if any, are to be borne by the business concern itself.
4. **Customer advance** :—The customer advance represents a part of the price of the products that have been ordered by the customer and which will be delivered at a later date. Generally, this advance is only in case of big orders & customers insist that the goods are supplied as per their requirements.
5. **Bank Credit** :—Commercial banks provide finance for short term by any of the following methods:
  1. **Loans** : Under this scheme customers are given full amount of loan in cash and its repayment is also done in one instalment. The borrower is required to pay the interest on the whole amount.
  2. **Cash Credit** : This is a running account from and to which withdrawals and deposits can be made frequently. The customer has to pay interest only on the amount actually utilised. Here, a borrower is allowed to borrow upto a certain limit against the security of assets, guarantees or promissory notes signed by two or more sureties.
  3. **Overdraft** : Here, the bank allows its customer to overdraw his current account. The customer is charged on the amount actually overdrawn.
  4. **Discounting of Bills** : Here, Banks finance the firm by discounting their credit instruments like bills of exchange, promissory notes and hundies at a price lower than their face value.

\*\*\*\*\*

## LESSON 4

---

# HUMAN RESOURCE MANAGEMENT

---

Of all the M's—Men, Money, Material, Machines, Methods, Men are by far the most important resource because all other resources by themselves cannot operate. It is through the combined efforts of men that all other resources are collected, coordinated and effectively utilized for the attainment of organisational objectives. **Renis Likert** rightly observed, “All the activities of any enterprise are initiated and determined by the persons who make up that Institution, plants, offices, computers, and all else that make a modern firm— managing the human component is the Central and most important task, because all else depends on how well it is done.”

The personnel, manpower, human resources or people at work of an organisation consist of all individuals engaged in any of the organisational activities, regardless of levels. Human resources from the national point of view means the knowledge, skills, creative abilities, talents and aptitudes obtained in the population; whereas from the viewpoint of the organisation, these represent the total of the inherent abilities, acquired knowledge and skills as exemplified in the talents and aptitudes of its employees.

**Jucius Michel** calls these resources ‘human factors’ which refer to, “a whole consisting of inter-related, inter-dependent and inter-acting physiological, psychological, sociological and ethical components.”

### Human Resource Management—Concept

The management of men is a challenging task because of the dynamic nature of the people. No two persons are similar in mental abilities, liking, disliking, values, faiths, perceptions, sentiments, actions, reactions and behaviour. People are responsive because, they feel, think and act; therefore, they cannot be operated like machine, money and material. Thus human resource management is a most crucial job because “managing people is the heart and essence of being a manager.” An organisation cannot succeed if this human element is neglected.

### Definition of Human Resource Management

Different experts of Personnel management/HRM have given different definitions, some of them are reproduced below to get an idea of what it means.

**Edwin B. Flippo** “The personnel function is concerned with the procurement, development, compensation, integration, and maintenance of the personnel of an organisation for the purpose of contributing towards the accomplishment of that organisation’s major goals or objectives. Therefore, personnel management is the planning, organising, directing, and controlling of the performance of those operative functions.”

**Dale Yoder** “Man power management effectively describes the processes of planning and directing the application, development, and utilisation of human resources in employment.”

**E.F.L. Brech** “Personnel Management is that part of management process which is primarily concerned with the human constituents of an organisation.”

**Pigors and Myres** “Personnel Administration is a method of developing the potentials of employees so that they get maximum satisfaction out of their work and give their best efforts to the organisation.”

**National Institute of Personnel Management of India** “Personnel management is that part of management which is concerned with people at work and with their relationship within the organisation. It seeks to bring

together men and women who make up an enterprise, enabling each to make his own best contribution to its success both as an individual and as a member of a working group.”

On the basis of the above definitions, the following features of human resource management can be identified:

1. It is a part of general management.
2. It concerns management of human resources.
3. It helps in the maximum development of personnel abilities so that they may feel satisfied with their work.
4. It establishes human relations at all levels in the organisation.
5. It includes planning, organisation, control and direction of man-power.
6. It is advisory in nature. It contributes to the success and growth of an organisation by advising the operating departments on personnel matters.
7. It is inter-disciplinary. It involves application of knowledge from several disciplines like psychology, sociology, anthropology, Philosophy, economics, Politics etc.
8. It is not a ‘one shot’ function but a never ending exercise and continues all the 365 days of a year.

### **Objectives of Human Resource Management**

According to *Michael J. Jucius*, personnel management should aim at:

- (i) attaining economically and effectively the organisational goals,
- (ii) serving the individual goals to the highest possible degree and
- (iii) preserving and advancing the general welfare of the community.

In the opinion of *Scott* “The objectives of personnel management in an organisation are to obtain maximum individual development, desirable working relationships between employers and employees, and to effect the moulding of human resources as contrasted with physical resources.”

*Ralph C. Davis* has divided the objectives of personnel management in an organisation into two categories:

- (a) Primary objectives, and (b) Secondary objectives.

**(a) Primary Objectives** The goal of personnel management is the creation of a work force with the ability and motivation to accomplish the basic organisational goals.

- (ii) To satisfy personal objectives of the members of the organisation through monetary and non-monetary devices. Monetary objectives include profit for owners, salaries/wages and other compensation for executives and employees. Non-monetary objectives include prestige, recognition, security, status etc.
- (iii) Thirdly, they relate to the satisfaction of Community such as serving customers honestly and promoting a higher standard of living in the community.

**(b) Secondary Objectives** aim at achieving the primary objectives economically, efficiently and effectively.

- (i) The economic need for or usefulness of the goods and services required by the community/ society.
- (ii) Conditions of employment for all the members of an organisation to their satisfaction and need so that they may be motivated to work for the success of the enterprise.
- (iii) The effective utilisation of people and materials.
- (iv) The continuity of the enterprise.



From the above discussion, the specific objectives of personnel management may be summarised as follows:

- (i) To ensure effective utilisation of human resources.
- (ii) To establish and maintain an adequate organisational structure of relationships among all the members of an organisation.
- (iii) To generate maximum development of human resources within the organisation by offering opportunities for advancement.
- (iv) To ensure respect for human beings by providing various services and welfare facilities to the personnel.
- (v) To ensure reconciliation of individual/group goals with those of the organisation.
- (vi) To identify and satisfy the needs of individuals by offering various monetary and non-monetary rewards.
- (vii) To achieve and maintain high morale among employees by securing better human relations.

### **Importance of Human Resource Management**

Management of human resource is of utmost significance and can be discussed under four headings.

**(a) Social Significance** The effective management of human resource is likely to serve the following social goals as indicated by Dole Yoder.

- (i) Helps to maintain even-balance between jobs and job holders and to raise living standards of individuals in the Society.
- (ii) To help people to avail of the best, most productive and most gainful jobs.
- (iii) To assist every member of the organisation in maximising the contribution and reward by developing talents in the job.
- (iv) To help to ensure the best protection and conservation of human resource to prevent its wasteful or careless use.
- (v) To help people to make their decisions with minimum of direction and control.

**2. Professional Significance:** Management of human resource serve the following professional goals:

- (i) Maintaining respect and dignity of the individual members.
- (ii) Providing maximum opportunities for personality development of each participant in the organisation.
- (iii) Ensuring effective allocation of services to different jobs.
- (iv) Ensuring effective utilisation of people's talents and interests in work-settings.

**3. Significance for an Enterprise** It can help the organisation in accomplishing its goals by:

- (i) creating right attitude among the employees through effective motivation;
- (ii) utilising effectively the available human resources;
- (iii) securing willing cooperation of the employees for achieving goals of the enterprise.
- (iv) attracting and retaining the right man on the right job.

**4. National Significance** The development of a country to a large extent depend on the quality, skill, knowledge and abilities of its people. Countries are underdeveloped because their people are backward, illiterate, unskilled or semi-skilled. Effective management and development of human resources help to speed up the process of economic development which in-turn raises the standard of living of its people.

## Scope of Human Resource Management

The field of personnel management is very wide as it is called by several terms such as, 'Labour Management', 'Manpower Management', 'Human Relations', 'Human Resource Management' and so on. The Indian Institute of Personnel Management has laid down the scope of personnel management as follows:

- (i) **The Welfare Aspect:** This aspect is concerned with working conditions and amenities such as canteens, creches, rest rooms, lunch rooms, housing, transport, education, medical help, health and safety, washing facilities, recreation and cultural facilities, etc.
- (ii) **The Labour or Personnel Aspect:** It is concerned with recruitment, selection, placement, induction, transfer, promotion, demotion, termination, training and development, Lay-off and retrenchment, wage and salary administration, incentives, productivity, etc.
- (iii) **The Industrial Relations Aspect:** It is concerned with trade unions, negotiation, settlement of industrial disputes, joint consultation and collective bargaining.

All these aspects are concerned with human element in industry as distinct from the mechanical.

**Dale Yoder** has classified the scope of personnel management in terms of the following functions:

- (i) Setting general and specific management policy for organisational relationship and establishing and maintaining a suitable organisation for leadership and co-operation.
- (ii) Collective bargaining, contract negotiation, contract administration and grievance handling.
- (iii) Staffing the organisation, finding, getting and holding prescribed types and number of workers.
- (iv) Aiding in the self-development of employees at all levels providing opportunities for personnel development and growth.
- (v) Developing and maintaining motivation for workers by providing incentives.
- (vi) Reviewing and auditing manpower management in the organisation.
- (vii) Industrial relations research carrying out studies designed to explain employees' behaviour and thereby affecting improvements in the manpower management.

## Functions of Human Resource Management (HRM)

The functions of HRM can be broadly classified into two categories viz;

1. Managerial functions, and
2. Operative functions

### 1. Managerial Functions

Managing people is the heart and essence of being a manager. Personnel manager is a manager and as such he must perform the basic functions of management like planning, organising, directing and controlling.

- (i) **Planning:** It is a pre-determined course of action. Planning is the determination of the plans, strategies, programmes, policies and procedures to accomplish the desired organisational objectives. For HRM, planning involves estimation of human resource requirements, recruitment, selection, training etc. It also involves formulation of personnel policies and programmes, forecasting personnel needs, and preparing the human resource budget etc.
- (ii) **Organising:** After plans have been developed, the HRM must establish an organisation to carry them out. This function involves grouping of personnel activities, assignment of tasks to different individuals and teams, delegation of authority and establishment of authority-responsibility relationship and integrating their activities towards the organisational objectives.

- (iii) **Directing:** This function involves motivating, guiding, leading and activating the personnel. Human resource manager must inculcate in the workers a keen appreciation of the enterprise policies. The willing and effective cooperation of employees for the attainment of organisational goals is possible through motivation and command.
- (iv) **Controlling:** It involves checking, measuring, verifying, correcting and assuring the accomplishment of plans. Auditing training programmes, analysing labour turnover records, directing morale surveys are some of the means to assure the human resource management that the activities are being carried out in accordance with the plans.

## 2. Operative Functions

The operative or service functions of human resource management are related to specific activities of procuring, developing, compensating and maintaining an efficient work force.

- I. **Procurement:** It is the first operative function of human resource management. Procurement is concerned with securing and employing the right kind of people in the right number on a right job at a right time to achieve the organisational objectives. It consists of the functions such as job analysis, human resource planning, recruitment, selection, placement, induction and internal mobility.
- II. **Development:** It is concerned with the personnel development of employees by improving the knowledge, skills, aptitudes, attitudes and values of employees to make them more competent and effective on their present and future jobs. This function includes:  
Performance appraisal, Potential appraisal, Performance counselling, Training and management development, Career planning and Development, Organisation development.
- III. **Compensation:** It is the process of providing equitable and fair remuneration to the employees. This function includes: Job evaluation, Wage and Salary administration, Incentives, Bonus etc.
- IV. **Integration:** It is concerned with the attempt to bring about a reasonable reconciliation of individual and organisational interests. It involves: Negotiations with labour unions, handling employees' grievances, developing sound human relations, establishing good relations with government agencies and educational institutions, workers' participation in management, employees' discipline etc.
- V. **Maintenance:** It is concerned with sustaining and protecting the physical and mental health of employees in the organisation. It includes several types of benefits such as housing, medical services, educational facilities, social security measures like provident fund, pension, gratuity, maternity benefits, health and safety measures, group insurance etc.
- VI. **Records, Research and Audit:** Personnel department maintains the records of the employees working in the organisation. Record-keeping is necessary both for exercising control over personnel activities and for doing research. This function involves: developing a good system of record keeping, carrying out research on various subjects and annual personnel audit.

## Role of Human Resource Manager

A human resource manager plays a variety of roles in accordance with the need of the situation. These are given below:

- 1. **The Conscience Role** under this role the human resource manager reminds the management of their moral and ethical obligations towards employees.
- 2. **The Counsellor Role** under this role he encourages the employees to meet him frequently for consultation and discussion of their mental, physical and career problems.
- 3. **The Mediator Role** He tries to settle disputes between labour and management, between an individual and a team and serves as a peace maker and linking-pin between different departments/divisions of an organisation.

4. **The Spokesman Role** under this role he works as a spokesman for his organisation.
5. **The Problem Solver's Role** He is a problem solver in respect of issues involving human resource management and overall organisational planning.
6. **The Change-Agent Role** He serves as a change-agent in respect of introducing and implementing major institutional changes. He is an innovator in personnel matters.
7. **The House Keeper Role** under this role he looks after the safety, health, welfare etc. of employees.
8. **The Decision-Making Role** He plays a dominant role in the decision-making process and takes decisions regarding both major and minor issues of the human resources. He formulates objectives, policies and programmes of human resource management.
9. **The Executive Role** Once decisions are taken he plays a dominant role in executing these decisions, programmes etc.
10. **The Clerical Role** He plays this role by time-keeping, calculating wages, salaries, allowances, incentives, compensation and maintaining of records and the like.

## Organisation of Personnel Department

Organisation requires the creation of structural relationships among the different departments, the people and other resources to achieve the desired objectives. In order to combine and coordinate the efforts of people working at different levels in the organisation, proper relationship among them in terms of authority and responsibility should be set up. For this any of the following types of organisation structure may be set up.

- (i) Line Organisation
- (ii) Line and Staff Organisation
- (iii) Functional Organisation

### I. Personnel Department in Line Organisation

It is the oldest and the simplest form of organisation structure and also known as the scalar or military organisation. Under this, the line of authority flows in straight line from top to the bottom of the organisation.

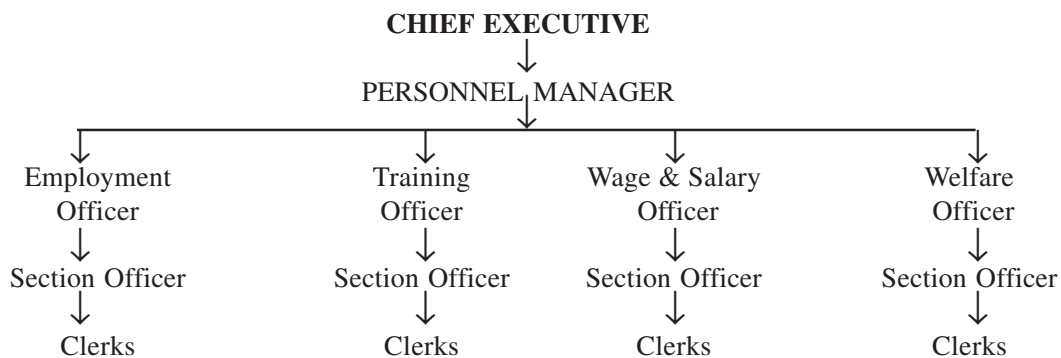

### II. Personnel Department in Line and Staff Organisation

In order to achieve the benefits of both the line and functional organisation structures, the line and staff structure has been evolved. Under it, staff positions are attached to line executives. Line refers to those positions which have the responsibility and authority and are accountable for accomplishment of organisational objectives. Staff elements are those which have responsibility and authority for providing advice and service to line in the attainment of objectives. Under this, personnel department provides advice and assistance on personnel matters to all departments. Line and Staff Organisation is more suitable to a large organisation:

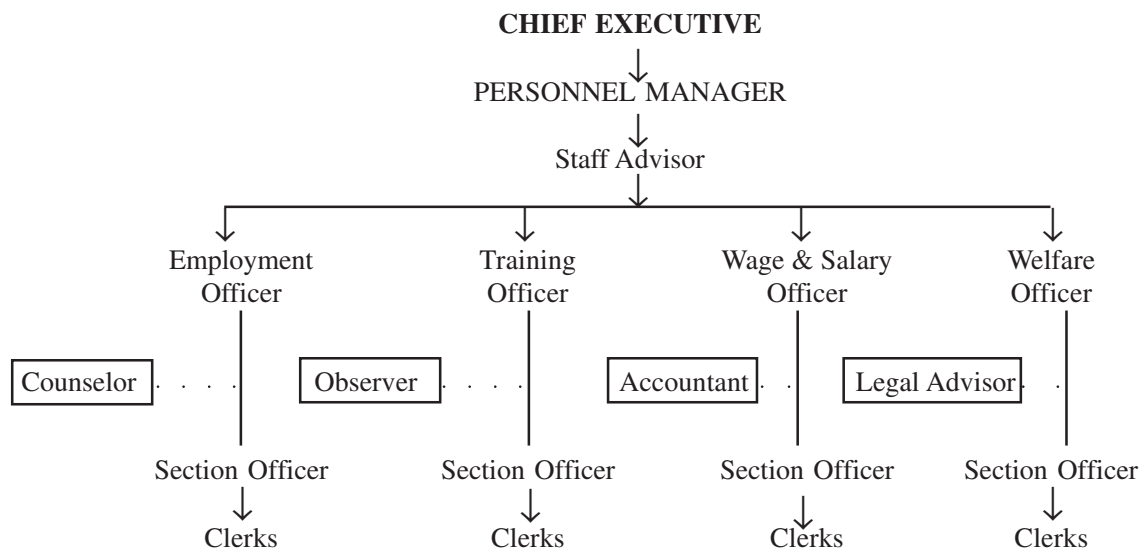

Line Responsibility \_\_\_\_\_

Staff Responsibility \_\_\_\_\_

### I. Personnel Department in Functional Organisation

Under this, all activities are grouped together according to certain functions like production, marketing, finance and personnel and each function is put under the charge of a specialist. Thus, each functional head performs a specialised function for the entire enterprise. The functional organisation is based on the concept of “*functional foremanship*” suggested by F.W. Taylor.

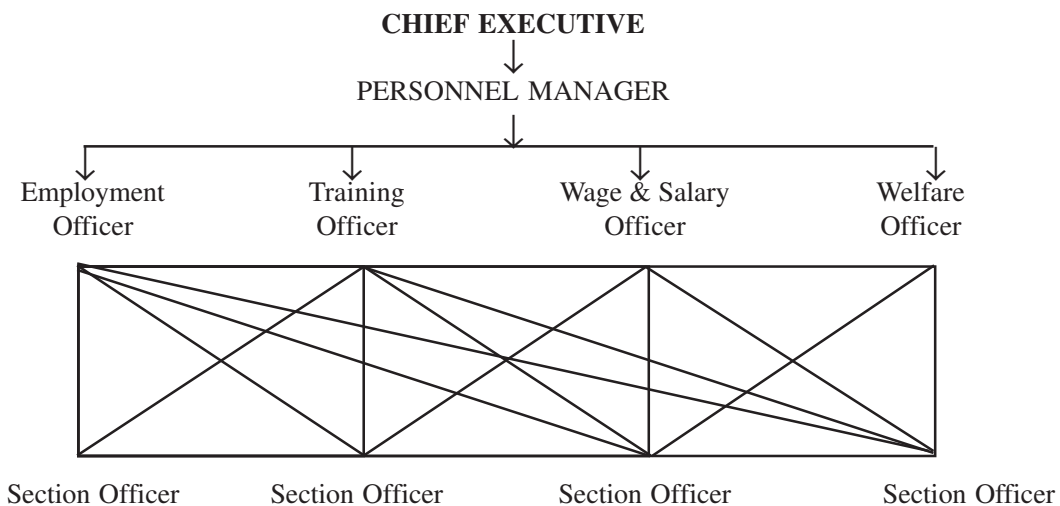

### IV. Personnel Department in Divisionalised Organisation

Divisionalisation is an alternative way of grouping organisational members by aggregating all the specialists needed to produce a given product or service. The principle here is one of assembling, within one department, individuals with complementary but diverse expertise rather than similar expertise. There are different kinds of divisionalisation like product, service, territories.

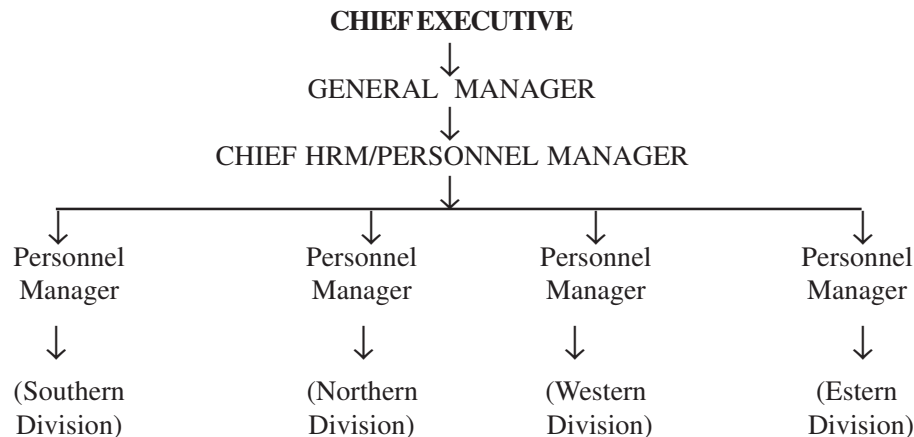

## V. Personnel Department in Matrix Structure

Under this method, every member is placed under dual authority i.e., bosses, one boss is the head of their own department to which the members permanently belong. The other is the head of the project to which they have been temporarily assigned. This method is often referred to as a **“Multiple Command System.”**

### Personnel Policies

‘Says Flippo, a policy is a man-made rule of pre-determined course of action that is established to guide the performance of work towards the organisational objectives. Personnel policies constitute guides to action. Personnel policies guide the course of action intended to accomplish personnel objectives.

The term, ‘Personnel Policy’ has been define by Richard P. Calhoon, “Personnel policies constitute guides to action. They furnish the general standards or basis on which decisions are taken. Their genesis lies in an organisation’s values, philosophy, concepts and principles.”

Personnel Policies refer to principles and rules of conduct which “formulate redefine, break into details and decide a number of actions” that govern the relationship with employees in the attainment of the organisational objectives.

Thus, personnel policies reflect the recognised intentions of top management with respect to the human resources of the organisation.

### Need for Personnel Policies

Every organisation should have personnel in order to accomplish the objectives of the personnel as well as the organisation. Dale S. Beach gave the following reasons to have personnel policies.

- (i) To consider the basic needs of the organisations and employees,
- (ii) To minimise favouritism and discrimination in treating the employees;
- (iii) To ensure that the action will be continued though the managers shift in key jobs;
- (iv) To have standards of performance.
- (v) To create and develop employee enthusiasm and loyalty.

### Advantages of Personnel Policies

Personnel Policies offer various advantages:



1. **Confidence** Policies make the employees aware of where they stand in the organisation and create confidence in them while confronting routine and recurring problems.
2. **Coordination** Personnel policies help the employees in predicting accurately the actions and decisions of others to ensure steady course of action.
3. **Continuity** It transmits the company's heritage from one generation of executives to another. The wisdom of an executive is retained in the form of written policy and successor can gain from the wisdom of their predecessors.
4. **Team-work** A well-prepared policy manual enables people at all levels of an organisation to see the institutional goals and the principles.
5. **Delegation of Authority** well written personnel policies help a manager to delegate authority as a written policy indicate what are expected from different persons. Buck passing on both sides is minimised.
6. **Decision-making** well defined personnel policies serve as guides for making sound decisions by summarizing past experiences.
7. **Uniformity** Sound personnel policies minimise discrimination, favouritism and personal prejudices and ensure uniform and consistent treatment of all employees.
8. **Management by exception.** The executive is free from repetitive, time consuming decisions and can devote more time to important decisions.
9. **Efficiency** sound policies enable the management to find out the variance between actual and standard performance so that he can correct such deviations.

### Coverage of Personnel Policies

In most organisations personnel policies generally cover the following subjects:

- (i) Recruitment and Selection.
- (ii) Training
- (iii) Compensation,
- (iv) Arrangement for work
- (v) Employee services and
- (vi) Industrial relations.

Michael Armstrong has classified the coverage of personnel policies on the basis of functions which are given below:

1. **Social Responsibility**—which includes equally treating the employees, quality of work, safety of life and health, safe and conducive working conditions.
2. **Employment Policies**—Provision of equal employment opportunities - selecting the candidates based on job requirement.
3. **Promotion Policies**—which should be fair and just for all employees.
4. **Development Policies**—include training programmes, techniques, rewarding system, qualifications and experience of the trainer, encouraging employees for self advancement, etc.
5. **Relation Policies**—includes policies regarding motivation, morale, communication, leadership styles, grievance procedure, disciplinary procedures, employee counselling.

\*\*\*\*\*

---

# CHANGE MANAGEMENT

---

Life is full of uncertainties; there is only one certainty and that is *change*. In fact, change is the law of life. It is relevant not only for individuals, but also for organisations. Change is a continuous phenomenon of organisational life. The survival and growth of an organisation depends to a great extent on its ability to cope with change required by forces operating within its boundaries and in its external environment. In this chapter, we shall study the concept and types of change, resistance to change and strategies to manage change.

## The Concept of Change

Change implies the creation of imbalances in the existing pattern of situation. It requires people to learn to cope up with change by making necessary adjustments. Organisations are also subject to change and so they are also required to manage change to remain profitable and effective.

Organisational change denotes *any alteration which occurs in the overall work environment of an organisation*. It has the following characteristics :

- (i) Change results from the pressure of forces which are both outside and inside the organisation.
- (ii) The whole organisation tends to be affected by change in any part of it.
- (iii) Change takes place in all parts of the organisation, but at varying rates of speed and degrees of significance.

## Strategic Change

Strategic change is a planned change which is necessitated by the changes in the external environment of business. The top management makes strategies of change to cope up with the following forces in the external environment :

- (i) **Technology:** It is the major external force which calls for change. The rate of technological changes is greater today than any time in the past and technological changes are responsible for changing the nature of jobs performed at all levels in the organisations. The computer technology and automation have made a remarkable impact on the functioning of organisations in the recent times. Technological advancement is thus a permanent fixture in the business world and it continues to demand the manager's attention as a pressure for change. Japanese firms have progressed rapidly because they are very fast in adopting new technological innovations.
- (ii) **Marketing Conditions:** Marketing conditions are no more static. They are in the process of rapid change as the needs, desires and expectations of the customers change frequently. Moreover, there is tough competition between manufacturers and suppliers in the market. The market is flooded with new products and innovations every day. New media of advertisement and publicity are being evolved for influencing the customers. All these factors put great pressure on the modern organisations to change their technologies and marketing strategies.
- (iii) **Social Changes:** Because of spread of education, knowledge explosion and Government's efforts, social changes are taking place at a fast pace. The drive for social equality (*e.g.*, equal opportunity to women, equal pay for equal work, etc.) has posed new challenges for the

management. The management has to follow social norms in shaping its employment, marketing and other policies.

- (iv) **Political Forces:** Political forces within and outside the country have an important influence on large business houses, particularly the transnational corporations. The relation between government and business houses has become very complex in modern times. The interference of government in business has increased tremendously in most of the countries. Many laws have been passed to regulate the activities of the corporate sector. The organisations have no control over the political and legal forces, but they have to adapt to meet the pressures of these forces.

## Types of Changes

Joseph L. Massie has identified the following types of changes in the manager's world :

1. **Changes in the Knowledge, Information and Techniques:** The profession of management has its deep roots in the engineering field which is advancing greatly. New techniques of production are being invented. Now a great deal of research is also being conducted in various institutions of the world on behavioural sciences. It is recognised that wherever a manager must deal with other persons, some aspect of behavioural sciences comes into play. Therefore, the application of behavioural sciences to the management field is getting top priority.
2. **Changes in Scope of Management:** The writings of early management thinkers were primarily concerned with technical problems and their solutions. But with the pressure of time, it was found that the process of management has universal application. Many problems in different types of organisations like industrial, educational, religious, hospital, etc. are common and they call for the application of certain management principles. This has broadened the scope of management and given birth to the demand for specialisation of the application of management knowledge.
3. **Changes in the Issues and Problems before Managers:** There has been a great change, both in magnitude and number, in the problems before present day managers. These changes are caused by the emergence of large scale organisations and the separation of management from ownership. Moreover, there has been an awakening of the working class. Trade unionism has spread throughout the world. Consumers have also become conscious about their power over the organisations.
4. **Changes in the Environment:** The world is changing fast, population changes are becoming extremely significant to managers. Other changes can be viewed as changes in consumers, factors of production, social conditions, political conditions and economic trends. The increase in the size of consumer markets and the segmentation of markets into strata have created new problems. Consumption patterns are changing widely and managers continually search for market information to help them make sound decisions. Values, expectations and aspirations of the customers are continually undergoing transformation.
5. **Change in the Pace of Change:** The changes facing the managers today are made even more significant by the increased rate of change in various dimensions such as speed of data handling, use of energy resources, etc. The types of changes and the differences in the rate of change will create an organisational world filled with uncertainty and problems. The manager facing the possibility of change must be prepared and willing to accept the conditions of uncertainty.

## Reactive vs. Proactive Change

Very few organisations adopt any change in a smooth and orderly way. Most of the organisations attempt to stick to old practices and procedures rather than planning change. For instance, workers in a factory have a long standing demand of profit sharing and they go on strike to press their demand. The change would be reactive if a profit-sharing plan is introduced because of pressure of the trade unions. Reactive change is brought by the management grudgingly since the survival of the organisation is in danger. But, if on the other

hand, the management introduces on its own a profit-sharing plan to enhance productivity and motivation of employees, such change would be called proactive or planned change.

Proactive change is a change that is initiated by an organisation because it is identified as desirable whereas reactive change is the change implemented by an organisation under pressure from environmental factors. **Planned change is a proactive approach.** Proactive management tries to anticipate the future and to see the organisation as it should be if it is to be effective in the future. Management will never be able to anticipate the future with total accuracy, but proactive planning can reduce those out-of-step periods that characterise reactive organisations.

### **Evolutionary, Revolutionary and Planned Changes**

Evolutionary changes are slow and there is a fear that organisation may not cope with the future. Revolutionary changes result in totally changing the *status quo* and these are dangerous except where situation becomes highly intolerable. Planned changes are systematically introduced by the management.

### **Planned Change**

A planned change is brought by an organisation with the purpose of achieving something that might otherwise be unattainable or attainable with great difficulty. This approach represents the planned alteration in the existing organisational system. It is a means of dealing with those changes that may be crucial for survival. It involves a greater commitment of time and resources; requires more skills and knowledge for successful implementation; and can lead to more problems if implementation is unsuccessful.

### **LEVELS OF CHANGE**

In the context of organisation, changes may occur at three levels, *i.e.*, individual level, group level and organisational level. These are discussed below :

#### **Individual Level Change**

Individual level changes may take place due to changes in job assignment, transfer of an employee to a different location or the changes in the maturity level of a person which occurs over a period of time. The general opinion is that change at the individual level will have impact on the group which in turn will influence the whole organisation. Therefore, a manager should never treat the employees in isolation, he must understand that the individual level change will have repercussions beyond the individual.

#### **Group Level Change**

Many of the organisational changes have their major effects at the group level. The groups can resist change, as for example, the trade unions can strongly resist the changes proposed by the management. Informal groups can pose a major barrier to change because of the inherent strength they contain. Changes at the group level can affect the work flows, job design, social organisation, influence and status systems and communication patterns.

The groups, particularly the informal groups, have a lot of influence on their individual members. As such, by effectively implementing change at the group level, resistance at the individual level can be overcome.

#### **Organisational Level Change**

The changes at the organisational level may take the following forms :

- (i) **Strategic Change:** It involves changes in the basic objectives and policies of the organisation. For example, joint venture with another firm, globalisation of operations, divestment of a loss-

making unit, etc. have far reaching consequences for the organisation and the individuals and groups working in the organisation.

- (ii) **Structural Change:** It involves changing the internal structure of the organisation. This change may be in the whole set of relationships, work assignments and authority structure. Change in organisation structure is required because old relationships and interactions no longer remain valid and useful in the changed circumstances.
- (iii) **Process Oriented Change:** Such changes relate to the technological developments, information processing and automation. They involve replacing or retraining personnel, heavy capital equipment investment and operational changes. All this will affect the organisational culture and as a result the behaviour pattern of the individuals and groups.
- (iv) **People Oriented Change:** People oriented changes are directed towards performance improvement, group cohesion, dedication and loyalty to the organisation. This calls for closer interaction among the employees and special behavioural training to them.

### **Causes of Resistance to Change**

People resist changes to protect themselves from the real or perceived effects of change. Man by nature resists what is unfamiliar to him. This is partly because he fears the new and unknown and partly because adopting of new ideas is a painstaking process. The resistance to change or opposition to change may be logical and justified in some cases. Sometimes, people do not resist change. They may oppose the change-agent or mode of implementing the change.

Human resistance to change may take the form of passive acceptance, subtle sabotage, aggressive refusal, complete breakdown of work and so on depending upon the situation. Resistance in any form is not a good sign of industrial relations in any undertaking. It is the duty of the management to restore and maintain the group equilibrium and personal adjustment which change upsets. Change requires individuals to make new adjustments for which they are not prepared. This causes resistance on their part.

Resistance to change may be caused by (i) economic, (ii) psychological, and (iii) social factors.

The **economic factors** causing resistance are as under :

- (i) Workers apprehend technological unemployment.
- (ii) Workers fear that they will be idle for a major portion of their time due to higher efficiency of new technology.
- (iii) Workers are afraid of demotion as they do not have the new skills required for the performance of new jobs.

The **psychological factors** of resistance are listed below :

- (i) It is the human psychology to maintain *status quo*. Human beings resist change by nature.
- (ii) Workers may apprehend boredom in new jobs because of increased automation.
- (iii) Workers may be lazy and reluctant to learn new things.
- (iv) Workers do not have complete knowledge about the change. They may make their own assumptions about change. The assumptions may be totally illogical.

The workers may resist change because of the following **social reasons** :

- (i) It may be felt by the workers that their status will go down as a result of introduction of new technology.
- (ii) Changes may require new social adjustments which are not liked by the workers.

- (iii) Workers as a group oppose change as they are unfamiliar with the change.
- (iv) Workers resist changes which are brought about without consulting them.

### **Causes of Organisational Resistance to Change**

At the organisational level also, change may be resisted. The main reasons for this are as under:

1. **Organisational Structure.** Some organisational structures have inbuilt mechanism for resisting change. Consider, for instance, a typically bureaucratic structure wherein jobs are narrowly defined, lines of authority are clearly spelt out and the flow of information is stressed from top to bottom. In such an organisation structure, new ideas rarely travel down the hierarchy because these are screened out. Innovations are not suitable for such an organisation.

2. **Resource Constraints.** Some organisations resist change due to scarcity of resources. Greater the scarcity of resources, greater is likely to be the resistance to change. An organisation may not like to incorporate change because it requires huge investment.

3. **Threat to Power.** When people at the top consider change as a potential threat to their position and influence, they resist it. Change may disrupt the power relationships and produce a new power equilibrium. This new equilibrium may reduce the power and prestige of some of the senior executives. Therefore, they would oppose the change.

4. **Sunk Costs.** An organisation may also resist change because it has invested in fixed assets and human resources. These costs cannot be recovered unless the assets and resources are put to productive use. When change is introduced, many of these costs become useless. That is why, existing machines may not be replaced with change in technology. Similarly, some executives may be retained despite their outdated skills and experience. Their pay and other benefits represent sunk costs.

### **Strategies to Overcome Resistance to Change**

Since it is natural for human beings to resist change, the main problem in introducing and implementing change is to overcome resistance to change. Efforts for overcoming resistance to change can be made both at the individual level and the group level. The main techniques that can be used to overcome resistance to change are given below:

1. **Education and Communication:** One of the simplest techniques to resistance to change is to inform people about the change. People can be educated to become familiar with the nature and process of change. Counselling and training can be used to change the basic values and attitudes of people. Communication is very useful because many people resist change due to lack of information or misunderstanding. While communicating change, a manager should explain :

- (a) What the change is ?
- (b) Why the change is needed ?
- (c) When it is to be introduced ?
- (d) How it will be implemented ?
- (e) How the change will be beneficial to all ?

This would help people to visualise the need for and logic of change. They would appreciate the change much better and will accept it easily. The main advantage of this method is that once convinced people themselves would help in the implementation of change. However, it is a time-consuming method and requires continuous education of those affected by the change.



2. **Participation and Involvement:** The management should discuss the change with the subordinates because people who have an opportunity to participate in planning for change will have some feeling of commanding their own destiny and not of being pushed around like so many pawns on a chessboard. Participation will give the people involved a feeling of importance. They are likely to be more committed to the change if they are convinced about the rationale of change. On the other hand, a change imposed from above is likely to make people feel that their knowledge and skills are being ignored.

3. **Education and Training:** In order to successfully implement the change, subordinates must be indoctrinated in new relationships, taught new skills, helped to change attitudes, given the information they need to understand where they fit into the picture and how they will be expected to operate under the new set-up. The educational process can be aided by training classes, meetings and conferences.

4. **Facilitation and Support:** Easing the change process and providing support for those caught up in it is another way managers can deal with resistance to change. These include listening, providing guidance, allowing time off after a difficult period, and offering facilitative and emotional support. Facilitative support means removing physical barriers in implementing change by providing appropriate training, tools, materials, etc. Emotional support is provided by showing personal concerns to the subordinates during periods of stress and strains.

5. **Negotiation and Agreement:** Negotiation with those resisting the change and offering them incentives may be a useful technique for overcoming resistance. Examples are union agreements, promotion of nominees of the union, increased economic benefits to employees, etc. It may become relatively easy to avoid major resistance through negotiation.

6. **Manipulation and Co-option:** Sometimes, managers covertly steer individuals or groups away from resistance to change. They may manipulate workers by releasing information selectively or by consciously structuring the sequence of events. Or they may co-opt an individual, perhaps a key person within a group, by giving him or her a desirable role in designing or carrying out the change process. Aside from the doubtful ethics of such techniques, they may also backfire.

7. **Explicit and Implicit Coercion:** Managers may force people to go along with a change by explicit or implicit threats involving loss of jobs, lack of promotion and the like. Managers may dismiss or transfer employees who stand in the way of change. As with manipulation and co-option, such methods, though not uncommon, are risky and make it more difficult to gain support for future change efforts.

## PLANNED CHANGE

Change may be either necessitated by the pressure of external forces or brought by deliberate and conscious efforts of the management. The latter type of change is called the volitional or **planned change**. According to Warren Bennis, "**Planned change encompasses the application of systematic and appropriate knowledge to human affairs for the purpose of creating intelligent action and choices.**" Planned change aims to relate to the basic disciplines of the behavioural sciences as engineering does to the physical sciences or as medicine relates to the biological sciences." The management may decide to go in for planned change to cope with complex problems of modern society and the growth of behavioural sciences.

Planned change may be defined as a conscious and concerted attempt of management of an organisation to monitor the environment, to assess their impact on the organisation and to evolve appropriate alternatives so as to utilise the environmental forces to the advantage of the organisation. Planned change is thus the intentional attempt by an organisation to influence the *status quo*. It is through planned change that an organisation can plan to bring changes for growth and development.



## Lewin's Change Model

Resistance to change could be overcome on an enduring basis by systematically planning and implementing the process of change. Kurt Lewin identified the following phases in the process of planned change :

(1) unfreezing the *status quo*, (2) moving to a new level, and (3) refreezing at the new level. These are discussed below :

(1) **Unfreezing.** It refers to making individual aware that the present behaviour is inappropriate, irrelevant, inadequate and hence unsuitable to the changing demands of the present situation. Edgar Schein outlines the following elements which are vitally necessary during this unfreezing phase :

- (i) Support for the old way of doing things must be removed by recognizing its inadequacies. The first stage is basically a fact-finding process. It is most effective when employees are fully involved, not merely told by management that changes will take place. For instance, an office wants to investigate replacing its typewriters with computers. The office manager would be wise to ask typists for their problems in using the old typewriters.
- (ii) Alternative plans of action should be evaluated and the best plan chosen. Again, employees' involvement in evaluation can be valuable in gaining their acceptance of the plan finally chosen. In the office we just mentioned, for example, the typists might be asked to try out computers and then report on their efficiency, filing space, convenience with floppy discs and ease of correction.
- (iii) Attempt should be made to gain commitment to change. To do this, the manager must overcome the natural resistance to change of those who are affected by it.
- (iv) If necessary, willingness to change should be linked with rewards and unwillingness to change with punishments.

(2) **Implementing Change:** Once the subordinates become receptive to change, the manager as a change agent, should introduce the proposed changes in a systematic manner with the full cooperation of the subordinates. They should be given intensive orientation as to the behavioural changes necessary for successful introduction of the proposed change so that adaptation to the new environment takes shape as desired.

(3) **Refreezing:** It is a phase of stabilisation, assimilation and institutionalization of the changes that are successfully implemented. Such changes should remain as a stable and permanent characteristic of the system until another need arises for change. The new roles, relationships and behavioural patterns should be allowed to take on the characteristics of habits. The subordinates should get a genuine feeling that the benefits generated by the change are worthwhile.

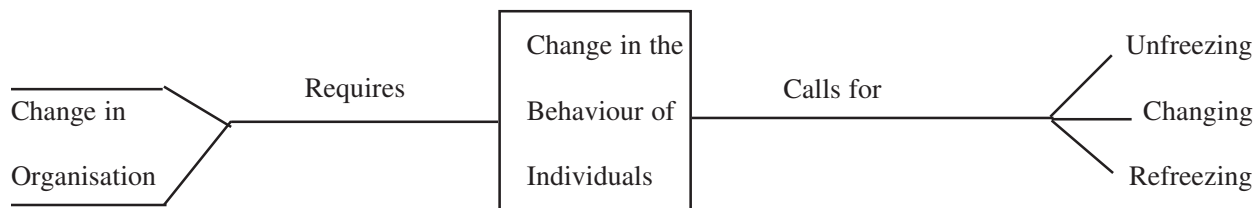
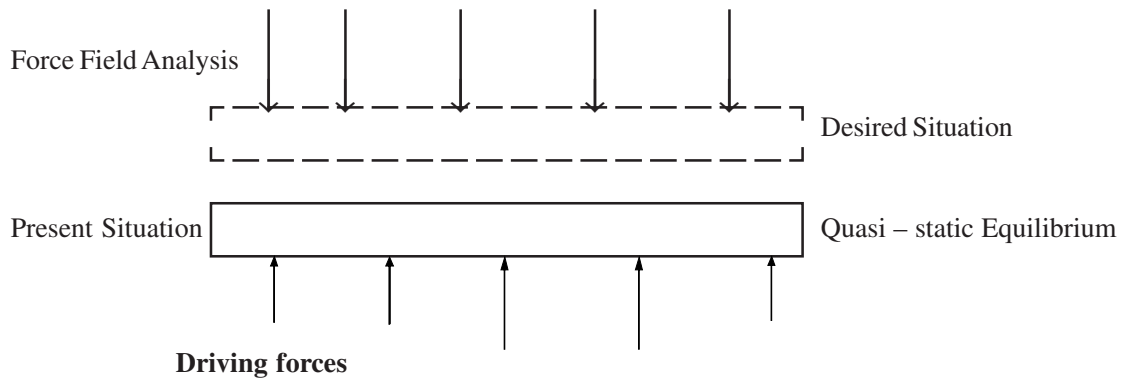

FIG.1. The Change Process

Although the success of a change attempt depends on completion of the latter two steps (moving and refreezing), an organisation's ability to adapt must first be determined by whether or not its current level of functioning can be unfrozen. That is, if the organisation neither perceives a need to change even if one actually

exists nor possesses the desire or ability to alter the *status quo*, voluntary changes will presumably not be initiated, thus ending possible organisational adaptation before it begins. Identification of the sources of organisational resistance to change, and the sources of impetus for change and the organisational characteristics that accommodate imbalance between these forces should be dealt with, since, obviously, the balance between these forces cannot be systematically upset (unfrozen) until the sources are identified.



**FIG. 2.** Lewin's Change Model (Forec-field Analysis)

Kurt Lewin introduced Force Field Analysis for implementing change. Force Field Analysis identifies (i) What forces are likely to push the change (*i.e.*, **driving forces**) and (ii) What forces are likely to restrain it (*i.e.*, **restraining forces**). The number and the strength of the driving and restraining forces must be identified. According to force-field theory, the present situation in which change is to be attempted to is a quasi-static equilibrium of driving forces and restraining forces as shown in Fig. 2. Organisational stability, or quasi-static equilibrium occurs when the driving and restraining forces balance each other in such a way as to maintain a constant level of functioning for a while.

The present equilibrium can be changed by strengthening the driving forces or by weakening the restraining forces. All these forces reside in the group. Lewin propounded that it is usually easier to change individuals formed into a group than to change any of them separately. As long as group standards are unchanged, the individual will resist changes more strongly the farther he is to depart from group standards. If the group standards are changed, the resistance which is due to the relation between individual and group standards would be eliminated.

The implication of Force Field Analysis for the manager is that before embarking on a change strategy, he must properly identify and evaluate the forces favouring change (driving forces) and those opposing change (restraining forces). This will enable him to remove the hindrances that block change efforts. He will not waste his time and energy on those forces over which he has no control. Under the framework of force-field analysis, a manager should take the following steps :

- (a) **Recognise the driving forces:** The first step towards organisational change involves reorganising major changes in the environment and problem within the organisation. In order to recognise the pressures to change, managers need to develop a keen sensitivity towards the external and internal environment.
- (b) **Increase the driving forces:** Once the need for change is identified, it needs to be communicated to the people concerned. If members know why the change is needed, they are more likely to adopt it.
- (c) **Manage the resisting forces:** People resist change because they perceive it to be harmful to them. It is, therefore, essential that they are made aware of its benefits. Rewards may be linked to willingness to change and resistance to change may be punished.

Unfreezing may be affected by encouraging the driving forces which take the behaviour away from the *status quo or the present state of affairs*. Alternatively, steps may be taken to overcome the restraining forces which tend to perpetuate the *status quo*. Several techniques are available for unfreezing., *e.g.*, **education, communication, participation in decision-making, negotiating offer of rewards, manipulation, coercion or punishment**, etc.

---

# MANAGEMENT OF CONFLICT

---

## Concept of Conflict

In every organisation there exists groups and individuals. Conflicts occur between the groups and between individuals within a group. The term 'conflict' is not synonymous with quarrel or fight. In management literature, the term conflict implies clash between individuals and groups due to opposing ideas, perceptions, goals, interests and values. Conflict may broadly be considered as a breakdown in the standard mechanism of decision-making. For example, when individuals working in an office are not able to reconcile their views there is breakdown of decision-making mechanism. Conflict implies lack of understanding and agreement among people.

Thus, organisational conflict may be defined as differences in the ideologies and approaches of groups and individuals working in the same organisation. The nature and intensity of conflict varies from group to group. Conflict between line and staff, between production and sales, between departmental heads on sharing of scarce resources, etc. are typical examples of organisation. The existence of conflicts among his subordinates complicates the job of a manager. Conflicts may create tension, hostility and lack of team-work and coordination in the organisation. However, conflicts are not necessarily harmful. Conflicts are unavoidable and a minimum level of conflict may be necessary for the good health of the organisation. Conflicts lead to rethinking and creativity. Conflicts may also help in identifying weaknesses, in releasing tension and in providing challenge to the members of the organisation.

Conflict exists in all organisation and it can take many forms. It may mean disagreement, hostility, contradiction may also imply policy differences or scarcity of resources. According to Robbins, 'Conflict is a process in which an effort is purposefully made by one person or unit to block another that results in frustrating the attainment of others goals or the furthering of his or her interests'.

The following are the important features of conflict:

- (i) Conflict occurs when two or more parties mutually exclusive goals, values or events. Since these values or goals are incompatible, one goal or value can be pursued only at the cost of another.
- (ii) Conflict refers to deliberate behaviour. If one party does not block the achievement of goals of others deliberately, it does not amount to conflict. Accidental interference is immaterial.
- (iii) Conflict is different from competition. In conflict, one party sees an opportunity to interface with the others opportunity to acquire resources or perform activity. In competition, both parties may try to win but neither party actively interferes with the other.
- (iv) Conflict is the opposite of cooperation. Cooperation implies mutual trust and confidence among employees in an organisation. They see the common superordinate goal and are



willing to help each other in achieving the goal. Cooperation is essential for the successful functioning of every organisation. On the other hand, conflict is harmful to the survival and growth of an organisation except in some cases. When the members of an organisation fail to see the common goal, conflict arises. They become too attached to their narrow departmental/personal goals which come in conflict with the achievement of overall organisational goals.

- (v) Conflict is a dynamic process. It indicates a series of events.
- (vii) There are three different management philosophies about conflict. According to the classical approach, conflict is an organisational abnormality. It is harmful and must always be avoided. Behavioural approach views conflict as harmful and to be avoided. But under this approach conflict is considered a natural occurrence in organisations. Modern experts believe that conflict is not only unavoidable but desirable. If handled properly, a minimum level of conflict is necessary for the health of organisations.

### Levels of Conflict

Conflict may exist at several levels which are as follows:

1. **Individual Level:** Conflict within the mind of an individual is called intra-individual conflict. Such conflict arises due to the following reasons:
  - (i) **Competing Goals:** Conflict occurs when a person has to choose between incompatible goals. There are three types of goal conflict.
    - (a) **Approach-Approach Conflict:** This type of conflict arises when a person has to choose between two equally attractive alternatives. For example, a person may have to choose between two equally profitable jobs.
    - (b) **Approach-Avoidance Conflict:** In this case, a person is faced with an alternative which has both positive and negative consequences. For example, a person has to work in a rural area if he wants promotion.
    - (c) **Avoidance-Avoidance Conflict:** This conflict arises because a person has to choose between two undesirable alternatives. For example, a person who dislikes his job wants to resign but is not sure of finding another job due to economic depression.
  - (ii) **Role Ambiguity:** When a person is not clear about his duties and what is expected from him in the job, conflict may arise. Conflict may also arise when an individual has to perform two divergent roles. For example, a supervisor faces conflict when workers and management both want him to be their representative. An individual also faces conflict when he is asked to perform a task which is against his value system or beyond his capacity.
2. **Group Level:** Conflict between members of a group is called interpersonal conflict. Such conflict may arise due to the following reasons:

- (i) **Personality Differences:** An introvert may find it difficult to get along with an extrovert. Conflict is common among persons having opposite temperaments, likes and dislikes.
  - (ii) **Perceptions:** Major differences in perception may lead to interpersonal conflicts. For example, production head and marketing head may not agree on quality.
  - (iii) **Clash of Values and Interests:** Differences in value system and ego state may create misunderstanding and conflicts among individuals. For example, one sales person may favour discounts to increase sales while another sales person may oppose it.
  - (iv) **Power and Status Differences:** Unequal distribution of power and status is often a cause of interpersonal conflict.
  - (v) **Scarcity of Resources:** Interpersonal conflict may occur when two individuals compete for some scarce facility such as a private room, private parking space, etc.
3. **Organisation Level:** Conflicts between groups is the most common type of conflict. Conflict between production department and marketing department, conflict between management and employee union, conflict between line officers and staff specialists are examples of intergroup conflict. Such conflicts arise due to the following reasons.

#### **Causes of Inter-group Conflicts**

The causes of inter-group conflicts are as follows:

- (i) **Difference in Goals:** Different groups have different views regarding goals. Division of work and departmentation make outlook narrow and people interpret the organisational goals in different ways. For example, individuals in production department may consider that maximum production at the lowest unit cost is the best way to achieve the profit goal. On the other hand, sales people may feel that maximum profit margin is the better approach. Conflicts also arise when individuals are not able to reconcile their personal goals with the goals of the organisation. Thus, differences in goals and in the means for achieving them can cause conflicts.
- (ii) **Joint Decision Making:** In many cases, two or more groups jointly take decisions. Such joint decision making may create intergroup conflicts when (a) different groups have different sources of information, (b) channeling of information to groups is blocked and (c) different groups use different techniques to process information.
- (iii) **Absorption of Uncertainty:** While interacting with its environment, an organisation faces uncertainty. A particular group may be asked to prescribe the manner for dealing with an uncertainty. For example, the accounting department may prescribe the rules for travelling expenses which may be opposed by marketing department.
- (iv) **Attitudinal Sets:** The attitudes which different groups hold towards each other may be



a source of conflict. When members of one group dislike and distrust those of another group, conflicts are likely to arise.

- (v) **Organisational Ambiguities:** Conflicts between departments may occur when their responsibilities, legal or other authorities overlap or are unclear.
- (vi) **Task Interdependence:** Conflicts arise when the tasks of two groups are interdependent and one group fails to meet the task demands of another group. Conflicts between production department and sales department is an example of such task interdependence. In addition personal dislikes, prejudices, jealousies and egos create conflicts.
- (vii) **Resource Sharing:** Conflicts often arise in the organisation because every group wants a higher share of the scarce organisational resources. Competition among the various groups or departments may lead to tension and conflict. Competition for rewards may also generate conflicts.

Inconsistencies in authority responsibility and communication patterns may create conflict. When one group tries to dominate over another group conflict is likely to occur.

### **Functional Aspects of Conflict**

Conflict can yield positive and negative consequences for an organisation. Advantages or functions of conflict can be as follows:

1. **Change Stimulant:** Conflict is integral to the process of change. It serves as a stimulus for change in the systems which are not conducive to the proper functioning of the organisation. Conflict spotlights problems that require change, forces clarification of their nature and sources, and channels efforts towards problem-solving. It compels individuals and groups to think again and again.
2. **Creativity and Innovation:** When a group is faced with a conflict, its members display creativity in identifying various alternatives. They think through and come out with imaginative solutions to tackle the problem. The thinking process generated by conflict may lead to innovations in policies and procedures.
3. **Group Cohesiveness:** Group cohesiveness implies commitment to group goals and the degree of cooperation among group members to work together. When a group faces threat from inside in the form of inter-group conflict, it tends to become more cohesive. Group unity is stressed. Members of the group cooperate to meet the pressure of conflict situation. As members show greater loyalty, the group becomes more closely knit.
4. **Release of Tension:** Conflict provides an opportunity for releasing tension which may otherwise remain suppressed. People can express their tension and frustrations by means of conflict. Conflict serves as a catharsis by providing an outlet through which members can negotiate their feelings without damaging the organisation's functioning.
5. **Test of capabilities:** Conflict is a test of the ability of people to learn and develop. It



provides challenge to them. If they are able to meet the challenge successfully, they will feel satisfied and highly motivated.

### **Dysfunctional Aspects of Conflict**

While the positive effects of conflict are few and limited, negative effects are many and serious. The main dysfunctions (dangers) of conflict are given below:

- (i) **Disequilibrium:** Conflict disturbs the equilibrium in the organisation. The contributions of individuals do not match their inducements because some of their energies are used in conflicting behaviour. No organisation can exist in disequilibrium for long. It will try to bring equilibrium either by increasing the contributions or getting rid of individuals whose contributions are low. Groups become opponent towards each other.
- (ii) **Tension and Stress:** Conflict affects the physical and mental health of people by creating tension and stress. Intensive conflict generates feelings of anxiety, guilt, frustration and hostility. Cooperation and coordination between individuals and groups become difficult due to a climate of suspicion and distrust. Conflict may be a source of dissatisfaction to the losing party.
- (iii) **Diversion of Energy:** Conflict diverts efforts towards destructive activities. People try to focus more on their personal goals rather than on organisational goals. They spend more time on designing tactics to win the conflict rather than on pursuing organisational goals. In extreme cases, even destructive and illegal activities may take place.
- (iv) **Rigidity:** Authority and responsibility relationships among members become more clearly defined. As a result the organisational structure becomes more rigid. Groups become more task-oriented and leadership becomes more directive.
- (v) **Distorted Communication:** Perceptions get distorted because each group develops negative perceptions towards the other. When in conflict members avoid interactions with each other. As a result communication ceases to exist. Groups apply a double standard when each group sees all the vicious acts of the other party but remains blind to its own faults.

Thus, conflict may weaken the organisations as a whole if the management is not able to handle it properly. Some competent and dynamic executives may leave the organisation.

### **Resolution of Conflict**

Functional conflicts need to be encouraged through reorganising, communication, competition, etc. But dysfunctional conflicts need to be resolved as early as possible.

The following methods may be adopted for resolving conflicts:

1. **Problem Solving:** In this technique, an attempt is made to bring the conflicting parties together and to share the mutual problem. The focus is on sharing of information to avoid misunderstanding and to find out areas of common interest. Question of who is

right or who is wrong is avoided. This method is suitable for resolving conflicts arising out of misunderstanding.

2. **Smoothing:** It is the process of suppressing differences existing between parties to the conflict and emphasising common interests. Sharing of opinions removes misunderstanding and both parties realise that they are not far apart. Smoothing or accommodating may be useful when the conflict is associated with aggressive feelings among the parties. However, it can be used only as a short-term measure for resolving conflict.
3. **Compromise:** This is a traditional method of resolving conflict. It is a process of bargaining wherein the parties negotiate on the basis of give and take to arrive at some agreement. There is no distinct winner or loser because each party is expected to sacrifice something in exchange for a concession. Compromise is commonly used where the conflict involves differences in goals, values or attitudes. It is effective when sought-after goal, e.g., resources-sharing can be divided between the parties.
4. **Dominance or Confrontation:** In this technique, parties to the conflict are left free to settle their score by mobilising their strengths and capitalising on the weakness of others. Parties use weapons like fights, arguments and frighten also to win over each other. One party's gain is another party's loss. This technique is adopted when both the parties adopt a very rigid stand. Confrontation may aggravate the struggle and contributes little to finding out innovative or constructive solutions acceptable to all. The stronger party ultimately dominates the weaker party.
5. **Avoidance:** It involves withdrawal of parties from the scene of the conflict. When parties to the conflict fail to arrive at mutually agreed solution, they may detach themselves from the conflict believing that avoidance is more mature and reasonable than wasting time and energy on childish arguments. They stay out of conflict and take no position on the issues involved. As a result, the conflict is neither resolved nor eliminated.

## Suggested Questions :

1. Define the term : Business System? What are the various sub-systems of the Business System and what is their signification?
2. (a) Write a note on centrepreneur vs Manager.  
(b) Discuss the contents of a feasibility study.
3. (a) Discuss the process of strategy formulation.  
(b) There can be no control without planning. Discuss the essential steps of control in management.
4. (a) What is marketing mix? Describe its components and factors influencing it.  
(b) What is financial management? What are its objectives? Explain.
5. Write short shorts on:
  - (a) Operative functions of HRM (Human Resource Management).
  - (b) Define matrix organisation? Discuss its merits and demerits.
  - (c) Causes of inter-groups conflicts.
  - (d) Product-life-cycle.
  - (e) Motivational theory of Herzberg and Mc Gregor.
  - (f) Types of communication.
  - (g) Management as a profession.
  - (h) E-Commerce